



Quality Products. Service Excellence.

150mw Audio Miniature Epoxy Potted 107 Series

PC Board Mount

Features



- Perfect for audio input, line matching, isolation or output transformer applications.
- 150 milliwatt (+/- 1.5 db, 300 Hz. - 50 KHz.)
- Epoxy potted in an attractive black molded case, Pin type P.C. board mount (min. 0.187" length).
- In some models where no center tap is required (on secondary), pin No. 5 is omitted.
- Power level ratings are maximum at lowest frequency rating (see charts & PDF spec. sheets below)
- Power can be increased slightly at higher frequencies (except 107X). See individual PDF specs. for specifics.
- Will withstand soldering for 10 sec. @ 260 degrees C, ambient temp. 85 degrees C max.

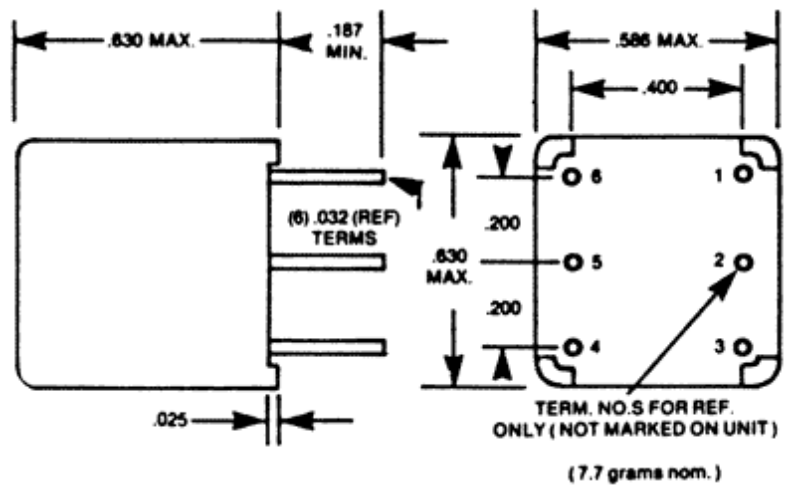

Part No.	Nominal Impedance (Ohms)		D.C. Resistance (Ohms) +/- 20%		Max. D.C. Unbalance (ma.)
	Primary (Pins 1-3)	Secondary (Pins 4-6)	Primary (Pins 1-3)	Secondary (Pins 4-6)	
107B	150 ct	12	20	2	12
107D	150 ct	150 ct	20	25	12
107E	600 ct	3.2	59	0.6	6
107G	600 ct	250 ct	59	10	6
107H	600 ct	600 ct	59	75	6
107J	1K ct	600 ct	92	71	4.5
107L	10K ct	3.2	780	0.65	1.5
107N	10K ct	600 ct	680	70	1.5
107P	10K ct	1.5K ct	680	150	1.5
107R	10K ct	4K ct	680	390	1.5
107T	10K ct	10K ct	680	700	1.5
107V	25K ct	600 ct	1300	70	1
107X	100K ct	1K ct	3700	80	0

© 2022. Hammond Manufacturing Ltd. All rights reserved.