

# High Power relay 50 A



Power generators



Back-up generators



Pump control



Disabled lift



Inverter





**Printed circuit mount - 3 mm contact gap  
50 A Power relay for photovoltaic inverters**

**Type 67.22-x300**  
- 2 NO

**Type 67.23-x300**  
- 3 NO

- Contact gap  $\geq 3$  mm (according to VDE 0126-1-1, EN 62109-1, EN 62109-2)
- DC coils, with only 170 mW holding power
- Reinforced insulation between coil and contacts
- 1.5 mm gap between PCB and relay base
- Suitable for use at ambient temperatures up to 85 °C (with energy-saving coil energization) or 70 °C (with standard coil energization)
- Meets the EN 60335-1 requirements of resistance to heat and fire (GWIT 775 °C and GWFI 850 °C)
- Cadmium free contact materials:
  - AgNi version (for applications where lower contact resistance is needed)
  - AgSnO<sub>2</sub> version (for applications where higher inrush current values are expected)

For outline drawing see page 8

**Contact specification**

Contact configuration

Contact gap mm

Rated current/  
Maximum peak current (for 5 ms) A

Rated voltage/  
Maximum switching voltage V AC

Rated load AC1/AC7a (per pole) VA

Rated load AC15 (per pole @ 230 V AC) VA

Single-phase motor rating (230 V AC) kW

Three-phase motor rating (480 V AC) kW

Breaking capacity DC1: 24/110/220 V A

Minimum switching load mW (V/mA)

Standard contact material

**Coil specification**

Nominal voltage (U<sub>N</sub>) V DC

Rated power W

Operating range (-40...+70)°C DC

Energy-saving mode (-40...+85)°C

Operating range for 1 s

Holding voltage range DC

Minimum holding power W

Must drop-out voltage DC

**Technical data**

Mechanical life cycles

Electrical life at rated load AC7a cycles

Operate/release time ms

Ambient temperature range (energy-saving mode) °C

Environmental protection

**Approvals** (according to type)

**67.22-x300**



- 2 NO
- Contact gap  $\geq 3$  mm
- PCB mount

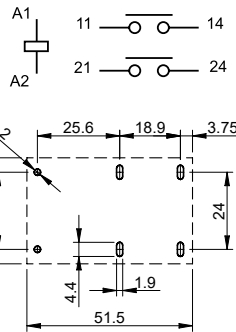

Copper side view

**67.23-x300**



- 3 NO
- Contact gap  $\geq 3$  mm
- PCB mount

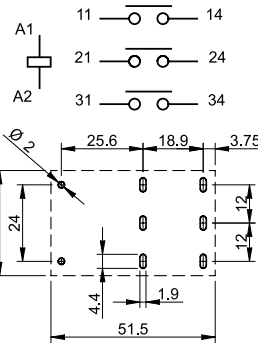

Copper side view

**Printed circuit mount - 5.2 mm contact gap  
50 A Power relay for photovoltaic inverters**

**Type 67.22-x500**  
- 2 NO

**Type 67.23-x500**  
- 3 NO

- Contact gap  $\geq 5.2$  mm (according to VDE 0126-1-1, EN 62109-1, EN 62109-2)
- DC coils, with only 170 mW holding power
- Reinforced insulation between coil and contacts
- 1.5 mm gap between PCB and relay base
- Suitable for use at ambient temperatures up to 85 °C (with energy-saving coil energization) or 60 °C (with standard coil energization)
- Meets the EN 60335-1 requirements of resistance to heat and fire (GWIT 775 °C and GWFI 850 °C)
- Cadmium free contact materials:
  - AgNi version (for applications where lower contact resistance is needed)
  - AgSnO<sub>2</sub> version (for applications where higher inrush current values are expected)

**67.22-x500**



- 2 NO
- Contact gap  $\geq 5.2$  mm
- PCB mount

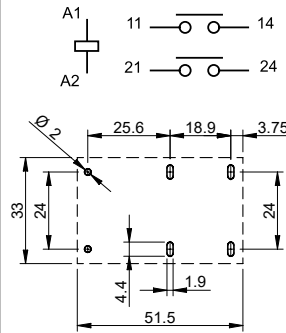

Copper side view

**67.23-x500**



- 3 NO
- Contact gap  $\geq 5.2$  mm
- PCB mount

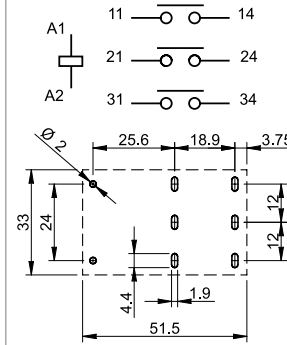

Copper side view

For outline drawing see page 8

**Contact specification**

Contact configuration		2 NO (DPST-NO)	3 NO (3PST-NO)
Contact gap	mm	$\geq 5.2$	$\geq 5.2$
Rated current/ Maximum peak current (for 5 ms)	A	50/150	50/150
Rated voltage/ Maximum switching voltage	V AC	400/690	400/690
Rated load AC1/AC7a (per pole)	VA	20000	20000
Rated load AC15 (per pole @ 230 V AC)	VA	2300	2300
Single-phase motor rating (230 V AC)	kW	2.2	2.2
Three-phase motor rating (480 V AC)	kW	—	11
Breaking capacity DC1: 24/110/220	A	50/7/2	50/7/2
Minimum switching load	mW (V/mA)	1000 (10/10)	1000 (10/10)
Standard contact material		AgSnO <sub>2</sub>	AgSnO <sub>2</sub>

**Coil specification**

Nominal voltage (U <sub>N</sub> )	V DC	5 - 6 - 8 - 12 - 24 - 48	
Rated power	W	2.7	2.7
Operating range (-40...+60)°C	DC	(0.90 ... 1.1)U <sub>N</sub>	(0.90 ... 1.1)U <sub>N</sub>
Energy-saving mode (-40...+85)°C	Operating range for 1 s	(0.95 ... 2.5)U <sub>N</sub>	(0.95 ... 2.5)U <sub>N</sub>
	Holding voltage range	(0.25 ... 0.5)U <sub>N</sub>	(0.25 ... 0.5)U <sub>N</sub>
	Minimum holding power	W	0.17
Must drop-out voltage	DC	0.05 U <sub>N</sub>	0.05 U <sub>N</sub>

**Technical data**

Mechanical life	cycles	1 · 10 <sup>6</sup>	1 · 10 <sup>6</sup>
Electrical life at rated load AC7a	cycles	30 · 10 <sup>3</sup>	30 · 10 <sup>3</sup>
Operate/release time	ms	30/4	30/4
Ambient temperature range (energy-saving mode)	°C	-40...+60 (-40...+85)	-40...+60 (-40...+85)
Environmental protection		RT II	RT II

**Approvals** (according to type)



## Ordering information

Example: 67 series solar relay, single PCB terminals, 2 pole NO, ≥ 3 mm contact gap.

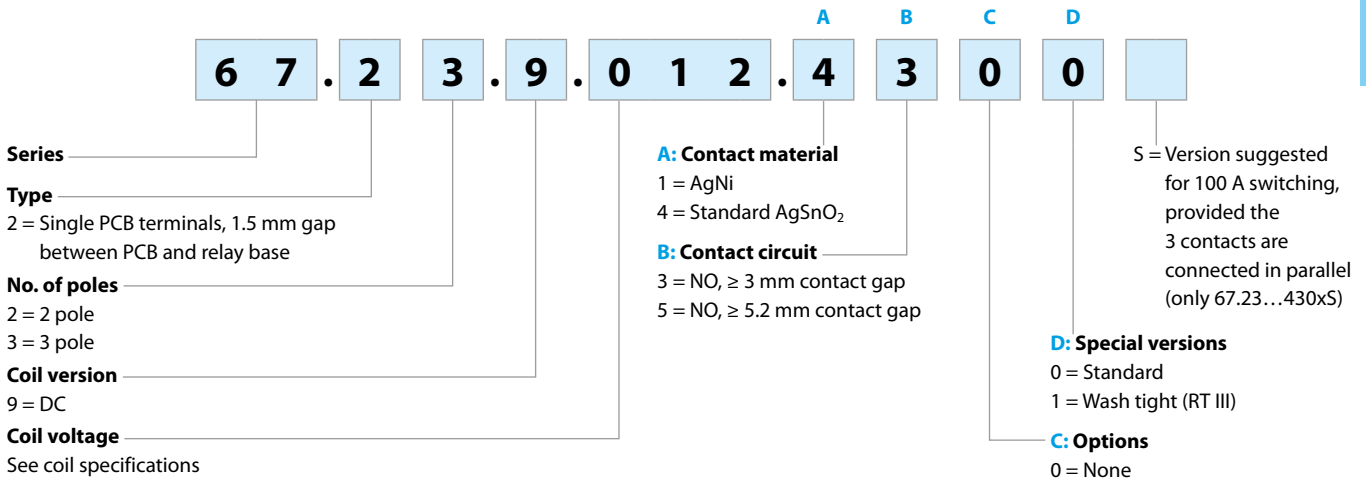

## Technical data

Insulation according to EN 61810-1				
Nominal voltage of supply system	V AC	400/690 3-phase	400 1-phase	230/400
Rated insulation voltage	V AC	630	400	400
Pollution degree		3		
Insulation between coil and contact set				
Type of Insulation		Reinforced		
Overvoltage category		III		
Rated impulse voltage	kV (1.2/50 μs)	6		
Dielectric strength	V AC	4000		
Insulation between adjacent contacts				
Type of Insulation		Basic		
Overvoltage category		III		
Rated impulse voltage	kV (1.2/50)μs	6		
Dielectric strength	V AC	2500		
Insulation between open contacts				
Type of disconnection		Micro-disconnection*		Full-disconnection
Overvoltage category		—		III
Rated impulse voltage	kV (1.2/50)μs	—		4
Dielectric strength	V AC	2500 (67.xx-x300)/3000 (67.xx-x500)		
Insulation between coil terminals				
Rated impulse voltage (surge) differential mode (according to EN 61000-4-5)	kV (1.2/50 μs)	4		
Other data				
Bounce time: NO	ms	2		
Vibration resistance (10...150)Hz: NO	g	15		
Shock resistance	g	35		
Power lost to the environment	without contact current	W	1.7 (67.xx-x300)/2.7 (67.xx-x500)	
	with rated current	W	8.5 (67.xx-x300)/9.5 (67.xx-x500)	
Recommended distance between relays mounted on PCB	mm	≥ 20		
Short circuit protection				
Rated conditional short circuit current	kA	5		
Back-up fuse for motor load	A	30 (delayed type)		

\* with overvoltage category II: Full-disconnection

## Contact specification

F 67 - Electrical life v contact current (AC1/AC7a load)

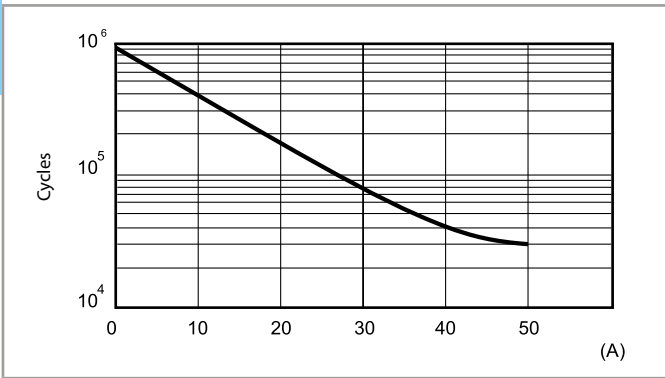

H 67-1 - Maximum DC breaking capacity (67.xx-x300)

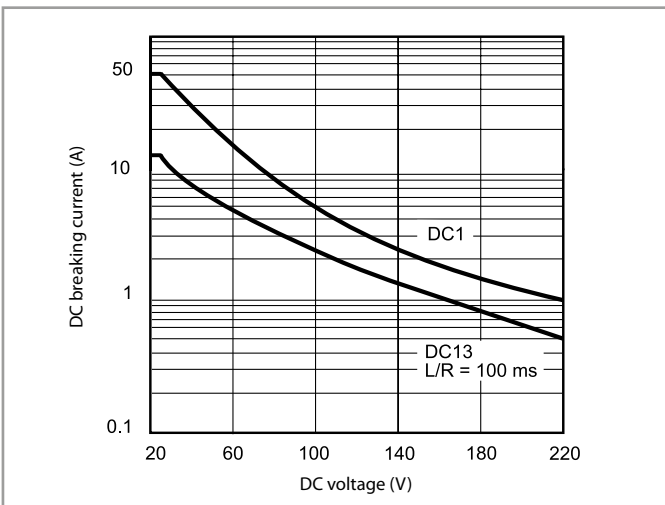

When switching a resistive (DC1) or inductive (DC13) load having voltage and current values under the corresponding curve, an electrical life of > 30000 cycles can be expected.

H 67-2 - Maximum DC breaking capacity (67.xx-x500)

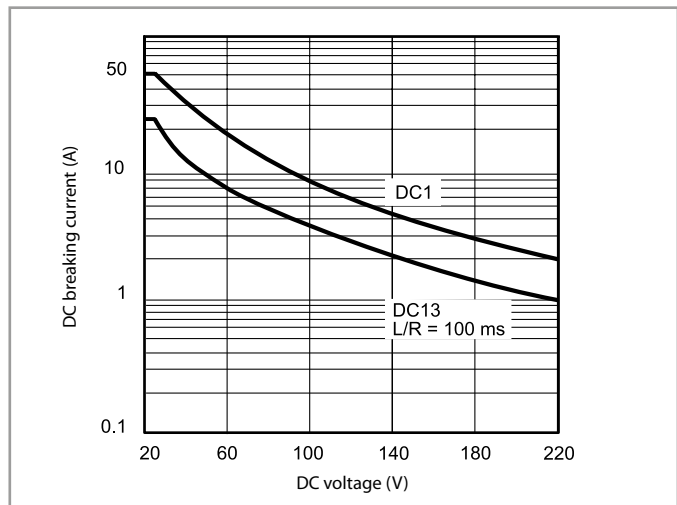

When switching a resistive (DC1) or inductive (DC13) load having voltage and current values under the corresponding curve, an electrical life of > 30000 cycles can be expected.

## Connection of contacts in parallel

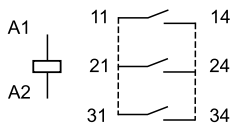

Connecting in parallel the contacts, with appropriate dimensioning of tracks on PC board, allow the relays to carry and switch loads up to 100 A:  
 - 100 A, with 67.23...4300S version  
 - 80 A, with 67.23...1300 version

## Coil specifications

### DC coil data, 67.xx-x300

Nominal voltage $U_N$	Coil code	Operating range (@ 70 °C max)		Holding voltage $U_h$	Resistance $R$	Rated coil consumption I at $U_N$ $I_N$
		$U_{min}$	$U_{max}$			
V		V	V	V	$\Omega$	mA
5	9.005	4.5	5.5	1.6	14.7	340
6	9.006	5.4	6.6	1.9	21.5	279
8	9.008	7.2	8.8	2.6	37.6	213
12	9.012	10.8	13.2	3.8	85	141
24	9.024	21.6	26.4	7.7	340	71
48	9.048	43.2	52.8	15.4	1355	35

### DC coil data, 67.xx-x500

Nominal voltage $U_N$	Coil code	Operating range (@ 60 °C max)		Holding voltage $U_h$	Resistance $R$	Rated coil consumption I at $U_N$ $I_N$
		$U_{min}$	$U_{max}$			
V		V	V	V	$\Omega$	mA
5	9.005	4.5	5.5	1.25	9.3	538
6	9.006	5.4	6.6	1.5	13.5	444
8	9.008	7.2	8.8	2	23.7	338
12	9.012	10.8	13.2	3	53.5	224
24	9.024	21.6	26.4	6	213	113
48	9.048	43.2	52.8	12	855	56

**R 67-1 - Operating range v ambient temperature, 67.xx-x300**  
with standard (continuous) coil energization (-40...+70)°C

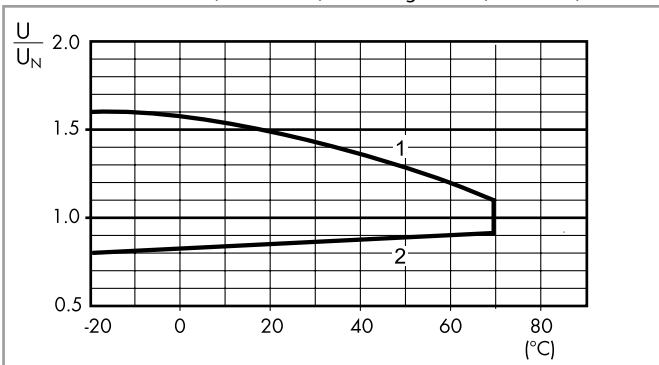

- 1 - Max. permitted coil voltage.
- 2 - Min. pick-up voltage with coil at ambient temperature.

### Energy saving mode

In some applications, such as photovoltaic inverters, it may be necessary to minimize the overall relay power dissipation and to permit use at higher ambient temperature levels (up to 85 °C). This can be achieved by initially applying a coil voltage within the Energy saving mode Operating range (see diagram to the right) and then rapidly (< 1 s) reducing the coil voltage to a level within the Holding voltage range. The lower the Holding voltage, the lower is the continuous power dissipation of the coil (0.17 W minimum).

Coil voltages as high as 2.5  $U_N$  may be used, when necessary, to reduce the contact operate time.

**R 67-2 - Operating range v ambient temperature, 67.xx-x500**  
with standard (continuous) coil energization (-40...+60)°C

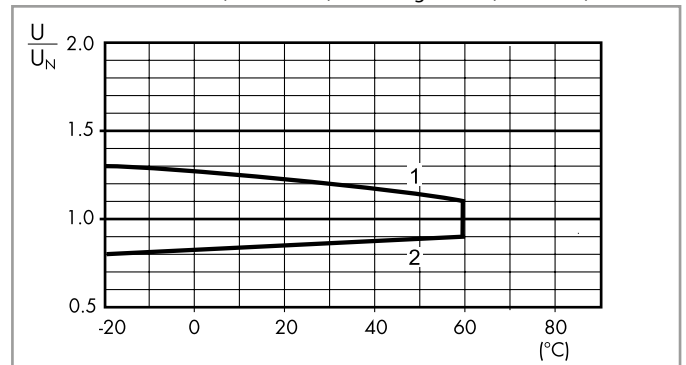

- 1 - Max. permitted coil voltage.
- 2 - Min. pick-up voltage with coil at ambient temperature.

**R 67-3 - Operating range v ambient temperature, 67.xx-x300/x500**  
in energy saving mode (-40...+85)°C

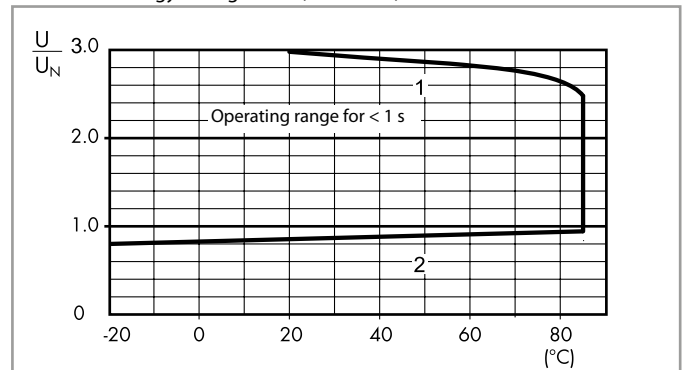

- 1 - Max. permitted coil voltage.
- 2 - Min. pick-up voltage with coil at ambient temperature.

Outline drawings

A

Type 67.22

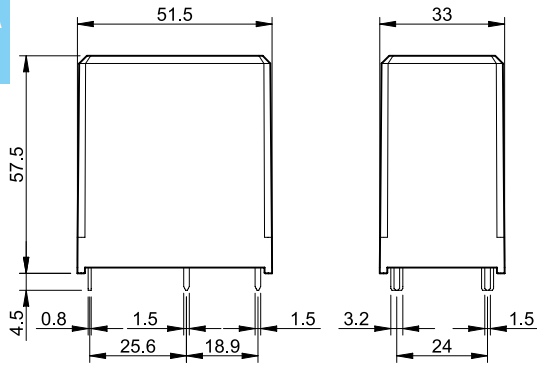

Type 67.23

