

CENTER PIN DIAMETER: $\varnothing 0.65\text{mm}$

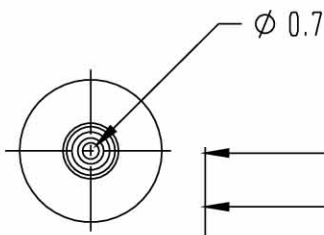

RoHS Compliance

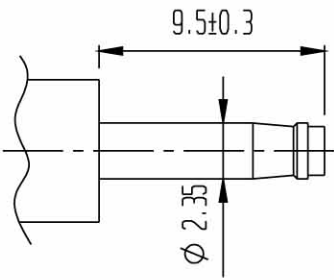
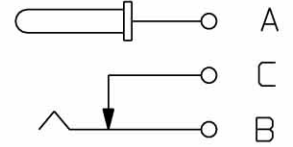
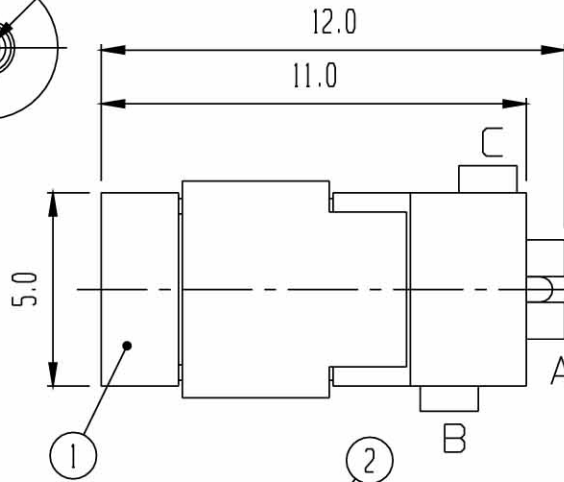

SCHMATIC

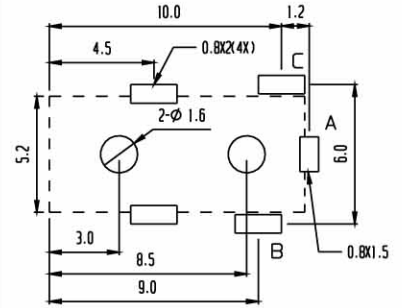

P.C.B. LAYOUT

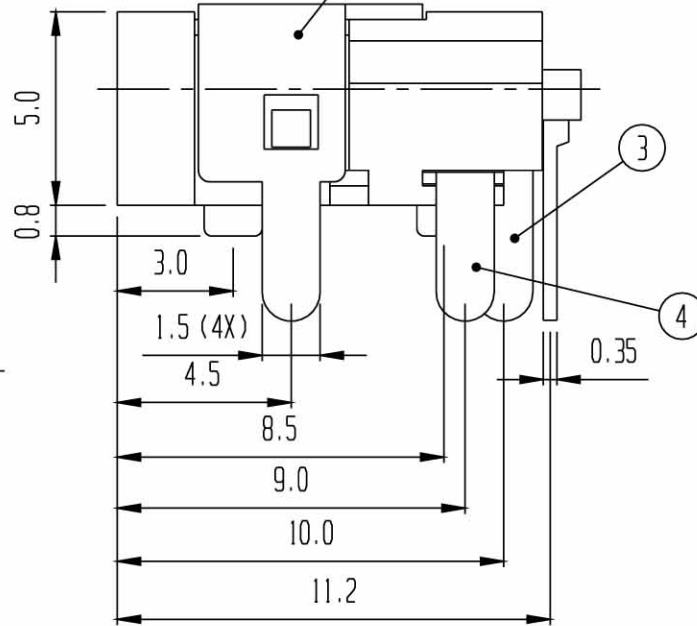
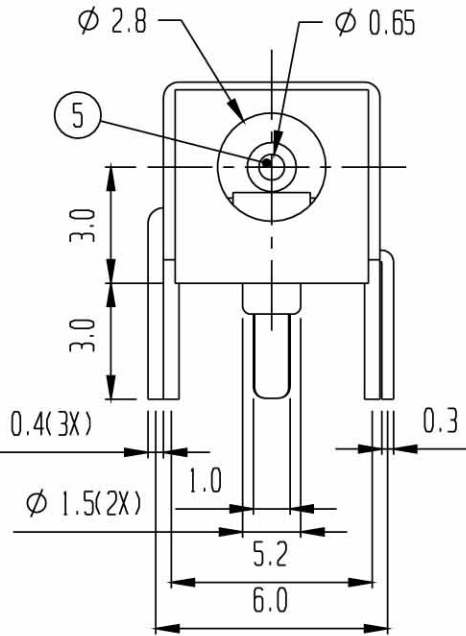

5	CENTER PIN	BRASS	1	Ag PLATED					
3	TERMINAL	BRASS	1	Ag PLATED	4	TERMINAL	P B S	1 Ag PLATED	
1	FRAME	P B T	1		2	TERMINAL	SPCC	1 Ni PLATED	
NO.	PART	MATERIAL	QTY	REMARKS	NO.	PART	MATERIAL	QTY	REMARKS

ISSUED

SPECIFICATION

TITLE: DC POWER JACK

RATING: DC 30V 0.3A

MODEL NO: SCD-028

CONTACT RESISTANCE: 50mΩ max.

INSULATION RESISTANCE: 100MΩ AT 500V DC

TOLERANCE UNIT: MM

DWN. *hwo*

WITHSTAND VOLTAGE: AC 250V for 1 minute

UP TO 1.0:±0.1 SCALE: 5:1

CHK'D. *pu*

OPERATION FORCE: REFER ATTACH SPECIFICATION

1.0 TO 10.0:±0.2 VERSION: 02

SWITCHING LIFE: 5,000 cycles min.

OVER 10.0:±0.3 DRWG NO:

APPD. *[Signature]*

BY: *[Signature]*

DATE: 05-JUL-2005

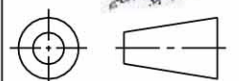



Product Specification

Part No.: SCD-028

- 1) **Rating:** DC 30V 0.3A
- 2) **Operating Temperature Range:** -10°C ~ +60°C
- 3) **Electrical Performance:**

	Test Conditions	Performance
Contact Resistance	Measured at small current (10mA 1000Hz or less)	50mΩ Max.
Insulation Resistance	Apply a voltage of 500V DC shall be applied for 1 minute after which measurement taken: (1) Between terminals not to be contact (2) Between body and terminal (3) Between terminals not to be contact when plug is inserted	100MΩ Min.
Dielectric Strength	AC500V rms (50-60Hz) for 1 minute trip current: 0.5mA (1) Between terminals not to be contact. (2) Between body and terminal (3) Between terminals not to be contact when plug is inserted.	Without damage to parts arcing or breakdown

4) **Mechanical Performance:**

	Test Conditions	Performance
Insertion Force	Measurement shall be made after 3 times of insertion and extraction with gauge plug	400~1000 gf
Extraction Force	Measurement shall be made after 3 times of insertion and extraction with gauge plug	300~900 gf
Terminal Strength	A static load of 150gf shall be applied to the terminal for 15 seconds in any direction	Electrical characteristics shall be satisfied without damage or excessive looseness of terminals
Life Test	Endurance without load: Jack shall be subjected to 5,000 cycles at a rate of 15 to 18 cycles per minute without loading.	(1) Contact resistance: 100mΩ Max. (2) Insulation Resistance: 50MΩ Min. (3) Withstand Voltage: AC 500V



		for 1 minute. (4) Without damage to parts arcing or breakdown.
--	--	---

5) Environmental Characteristics:

	Test Conditions	Performance
Solderability Test	The top of terminals shall be dipped 2mm in the solder bath of 260±5°C for 3±0.5 seconds	The Area of soldering should be over 75%
Resistance to Solder Heat Test	Solder Bath method: Solder temperature 260±5°C Immersion Time 3±0.5 seconds Immersion depth up to the surface of the board 1.6mm dimensions of component holes in the printed wiring board shall be in accordance with those specified in this document. Solder iron method: temperature of solder 350±10°C time of solder 3±0.5 sec.	Without deformation of case or excessive looseness of terminals electrical characteristics shall be satisfied.
Cold Test	The jack shall be stored at a temperature of -25± 3°C for 48 hours, then the switch shall be maintained at standard atmospheric conditions for 1 hour after which measurement shall be made	There shall be no deformation or cracks in the molded part.
Heat Test	The jack shall be stored at a temperature of 70±2°C for 48 hours, then the jack shall be maintained at standard atmospheric conditions for 1 hour after which measurement shall be made.	
Humidity Test	The jack shall be stored at a temperature of 40±2°C and a humidity of 90% to 98% for 48 hours, then the jack shall be maintained at standard atmospheric conditions for 1 hour after which measurement shall be made.	There shall be no deformation or cracks in molded part.
Test Condition (Unless otherwise specified) Temperature: 5°C - 35°C Humidity: 45% - 85% R.H. Pressure: 86 – 106kPa		

