

6	5	4	3	2	1		
APPROVED: _____			Rev	AWO #	Description	Date	Appr
DATE: _____ TITLE: _____			-		RELEASED	2/9/21	

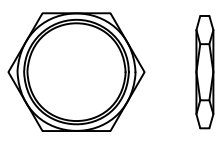

HEX NUT

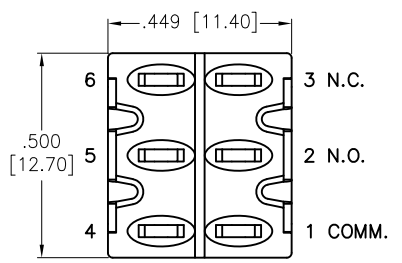
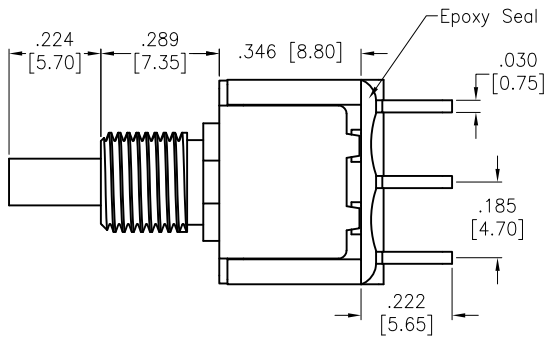
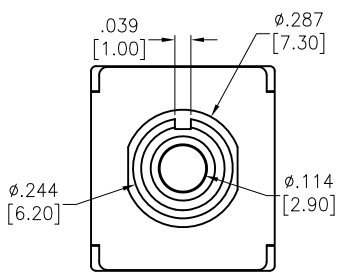
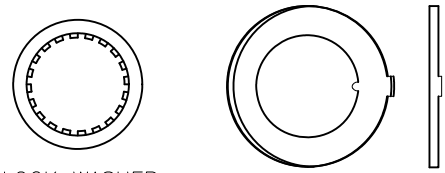

LOCK WASHER

ANTI ROTATIONAL WASHER

INCLUDED HARDWARE

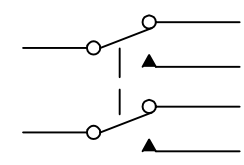
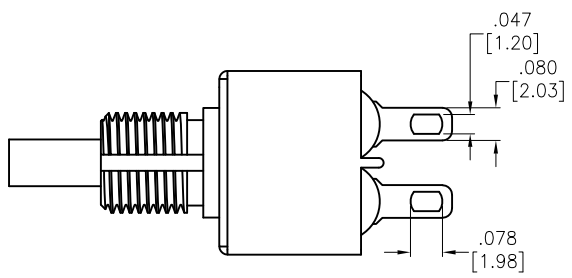

CIRCUIT DIAGRAM  
(DPDT) ON-MOMENTARY

SPECIFICATIONS:

Material:  
 Movable Contact: Copper Alloy, Silver Plated  
 Terminal: Copper Alloy, Silver Plated  
 Electrical:  
 Voltage rating: 120VAC or 38VDC  
 Current rating: 1 Amps  
 Contact resistance: 10 mΩ max  
 Insulation resistance: 1,000 Mohms min  
 Dielectric withstanding voltage: 1,500V RMS @Sea level  
 Temperature Rating:  
 Operating temperature: -30°C to +85°C  
 Environmental:  
 Lead free, RoHS compliant



UNLESS OTHERWISE SPECIFIED ALL DIMENSIONS ARE INCHES [MM] TOLERANCES: EXCEPT AS NOTED		
INCHES		HOLES
.X ± .10	Ø.X ± .10	
.XX ± .020	Ø.XX ± .015	
.XXX ± .015	Ø.XXX ± .010	
APPROVALS		DATE
DRAWN	LH	2/9/21
CHECKED	AC	2/9/21
APPROVED		

**ADAM TECH** 909 Rahway Avenue,  
 Union, NJ 07083  
 Phone: 908-687-5000  
 Fax: 908-687-5710

TITLE: SNAP-ACTING PUSH BUTTON SWITCH, DPDT,  
 ON-MOMENTARY, SILVER PLATED, SOLDER TYPE

SIZE X	PART NO. SW-PB8-BB00A1QE-1	REV. -
REF: S00198T	SCALE: NTS	SHEET 1 OF 1