

APPROVED: _____
 DATE: _____ TITLE: _____

Rev	AWO #	Description	Date	Appr
-		RELEASED	11/2/21	
A		UPDATED SPEC.	11/8/21	JJ/RC

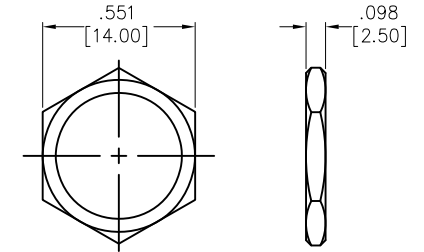

NUT

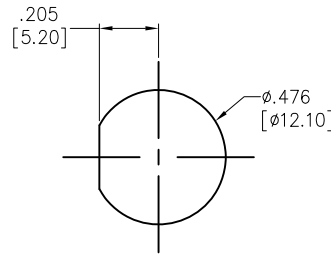
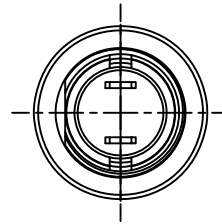
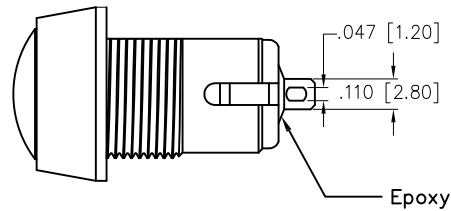
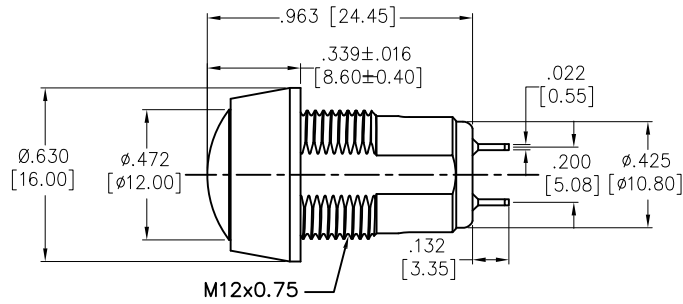
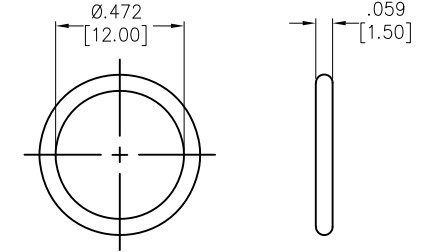

O-RING

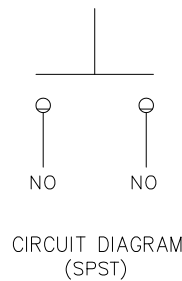

CIRCUIT DIAGRAM (SPST)

SPECIFICATIONS:

Material:
 Bushing: Stainless Steel, Varnish polished
 Contact Material: Copper Alloy,
 Plating: Gold over Silver

Electrical:
 Switch Rating: 100mA @ 24V DC
 2A @ 125V AC

Contact resistance: 50 mΩ max initial.
 Insulation resistance: 1G ohms min @ 500 VDC
 Dielectric withstanding voltage: 1000 VAC for 1 minute
 Electrical Life: 1,000,000 cycles min.
 Temperature Rating:
 Operating temperature: -30°C to +85°C

Environmental:
 Water proof: IP67

Lead free, RoHS compliant



UNLESS OTHERWISE SPECIFIED ALL DIMENSIONS ARE INCHES [MM]. TOLERANCES: EXCEPT AS NOTED

INCHES		HOLES	
.X	± .10	ØX	± .10
.XX	± .020	Ø.XX	± .015
.XXX	± .015	Ø.XXX	± .010

DRAWN	JJ	11/2/21
CHECKED	RC	11/2/21
APPROVED		

THIS DRAWING CONTAINS INFORMATION THAT IS PROPRIETARY AND SHOULD NOT BE USED WITHOUT PRIOR WRITTEN PERMISSION FROM ADAM TECH



909 Rahway Avenue,
 Union, NJ 07083
 Phone: 908-687-5000
 Fax: 908-687-5710

TITLE
 SWITCH, ANTI-VANDAL SEALED, PUSH BUTTON,
 SOLDER SPST, 12mm, MOMENTARY

SIZE	PART NO.	REV.
X	SW-PB7-04MB42ARM	A
REF: S00198T	SCALE: NTS	SHEET 1 OF 1