

APPROVED: \_\_\_\_\_

DATE: \_\_\_\_\_ TITLE: \_\_\_\_\_

Rev	AWO #	Description	Date	Appr
-		RELEASED	11/2/21	
A		UPDATED SPEC.	11/8/21	JJ/RC

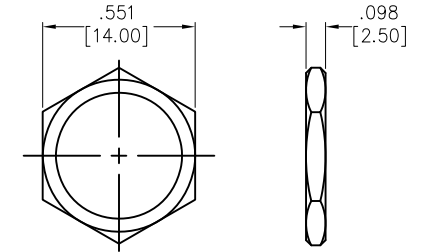
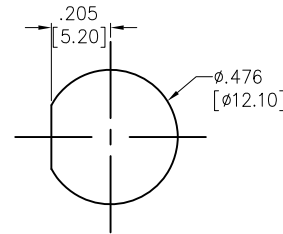
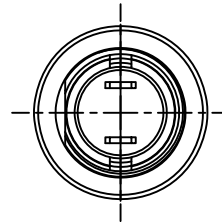
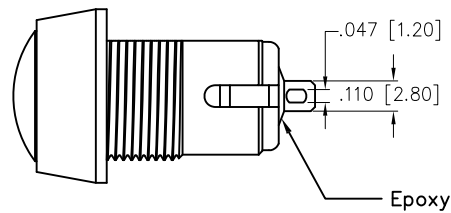
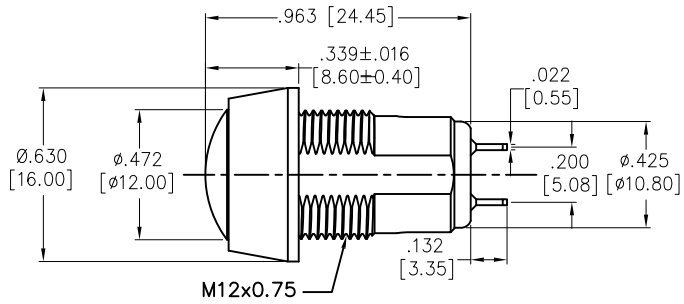

NUT

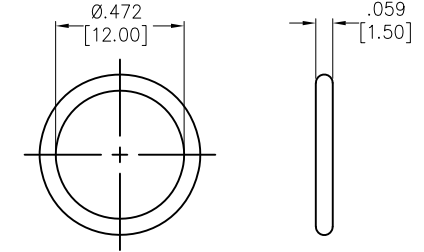

O-RING

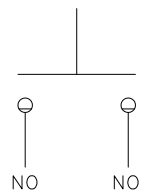

CIRCUIT DIAGRAM (SPST)

SPECIFICATIONS:

Material:

Bushing: Aluminum Alloy, Nickel plated

Bushing Color: Black

Contact Material: Copper Alloy,

Plating: Gold over Silver

Electrical:

Switch Rating: 100mA @ 24V DC

2A @ 125V AC

Contact resistance: 50 mΩ max initial.

Insulation resistance: 1G ohms min @ 500 VDC

Dielectric withstanding voltage: 1000 VAC for 1 minute

Electrical Life: 1,000,000 cycles min.

Temperature Rating:

Operating temperature: -30°C to +85°C

Environmental:

Water proof: IP67

Lead free, RoHS compliant



UNLESS OTHERWISE SPECIFIED ALL DIMENSIONS ARE INCHES [MM]. TOLERANCES: EXCEPT AS NOTED

INCHES	HOLES
.x ±.10	ØX ±.10
.XX ±.020	ØXX ±.015
.XXX ±.015	ØXXX ±.010



909 Rahway Avenue,  
Union, NJ 07083  
Phone: 908-687-5000  
Fax: 908-687-5710

DRAWN	JJ	11/2/21
CHECKED	RC	11/2/21
APPROVED		

TITLE  
**SWITCH, ANTI-VANDAL SEALED, PUSH BUTTON,  
SOLDER SPST, 12mm, LATCHING**

THIS DRAWING CONTAINS INFORMATION THAT IS PROPRIETARY AND SHOULD NOT BE USED WITHOUT PRIOR WRITTEN PERMISSION FROM ADAM TECH

SIZE <b>X</b>	PART NO. <b>SW-PB7-04B4WAR</b>	REV. <b>A</b>
------------------	-----------------------------------	------------------

REF: S00198T	SCALE: NTS	SHEET 1 OF 1
--------------	------------	--------------