

2315.2

RKD 4/LED2(RD)/60V DC BG

RKD 4/LED2(RD)/60V DC BG

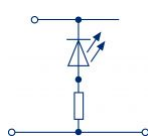
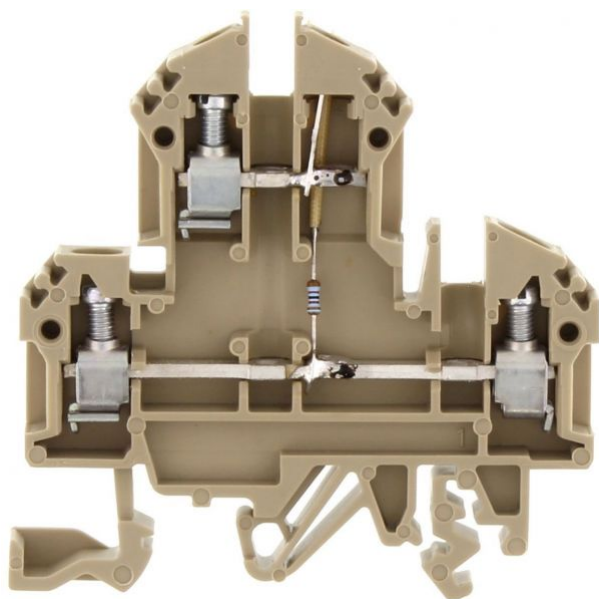

M3



EAC



Double-level terminal with electronic components, Screw connection, Mounting type: Mounting rail TS 35/7.5 and TS 32, Rated cross-section: 4 mm², Width: 6 mm, Colour: Beige

Business data

Product description	Double-level terminals with electronic components
Packaging unit	100
Quantity unit	PC
Weight per piece (not including packaging)	14
Weight per piece (including packaging)	14.77
Unit of weight	G
Customs number	85369010
Country of origin	DE

2315.2

RKD 4/LED2(RD)/60V DC BG

RKD 4/LED2(RD)/60V DC BG

Technical Data

Dimensions

Length	60.2 mm
Width	6 mm
Height TS 35/7.5	61 mm
Height TS 32	65.5 mm

Ratings

Rated voltage	60 DC V
Rated current	10 A
Rated cross-section	4 mm ²
Rated impulse voltage	6 kV
Overvoltage category	III
Contamination degree	3

2315.2

RKD 4/LED2(RD)/60V DC BG

RKD 4/LED2(RD)/60V DC BG

Technical Data

Connection data

Connection principle	Screw connection
Connection position	Lateral
Number of terminals per level	2
Number of levels	2
Wire cross-section single-core (rigid) / stranded, min.	0.2 mm ²
Wire cross-section single core (rigid)/stranded, max.	4 mm ²
Wire cross-section stranded, min.	0.2 mm ²
Wire cross-section stranded, max.	4 mm ²
Wire cross-section stranded with wire-end ferrules, min.	0.2 mm ²
Wire cross-section stranded with wire-end ferrules, max.	4 mm ²
Wire cross-section AWG, min.	22
Wire cross-section AWG, max.	12
Stripping length	9 mm
Screw head	Slotted
Screw threading	M 3
Tightening torque, min.	0.5 Nm
Tightening torque, max.	1 Nm

2315.2

RKD 4/LED2(RD)/60V DC BG

RKD 4/LED2(RD)/60V DC BG

Technical Data

Materials

Insulation housing	Polyamide 6.6
Flammability class UL 94	V-2
Working temperature, min.	-40 °C
Working temperature, max.	105 °C

Further technical data

Mounting type	Mounting rail TS 35/7.5 and TS 32
Gauge plug acc. to EN 60 947-1	A4
Number of cross-connection channels	2
End plate required	✓
Voltage illuminated display	60 DC V
Cross-current via illuminated display	5 mA
Colour of lamp	Red

2315.2

RKD 4/LED2(RD)/60V DC BG

RKD 4/LED2(RD)/60V DC BG

Approvals

Standards and regulations

EAC approval	TR ZU 004/2011
--------------	----------------

EAC approval granted	✓
----------------------	---

CSA approval

CSA approval	C22.2 No 158
--------------	--------------

CSA approval granted	✓
----------------------	---

CSA Usegroup C: rated voltage	300 V
-------------------------------	-------

CSA Usegroup C: rated current	25 A
-------------------------------	------

CSA wire cross-section AWG, min.	22
----------------------------------	----

CSA wire cross-section AWG, max.	12
----------------------------------	----

CSA stripping length	9 mm
----------------------	------

CSA torque, max.	1 Nm
------------------	------

CSA torque, min.	0.5 Nm
------------------	--------

2315.2

RKD 4/LED2(RD)/60V DC BG

RKD 4/LED2(RD)/60V DC BG

Approvals

German Lloyd approval

GL approval	IEC 60947-7-1
GL approval granted	✓
GL rated voltage	500 V
GL rated current	34 A
GL rated cross-section	4 mm ²
GL environmental category	C

KEMA KEUR approval

KEMA KEUR approval	EN 60947-7-1
KEMA KEUR approval granted	✓
KEMA rated voltage	500 V
KEMA rated current	32 A
KEMA rated impulse voltage	6 kV
KEMA wire cross-section single core (rigid), min.	0.2 mm ²
KEMA wire cross-section single-core (rigid), max.	4 mm ²
KEMA wire cross-section stranded, min.	0.2 mm ²
KEMA wire cross-section stranded, max.	4 mm ²

2315.2

RKD 4/LED2(RD)/60V DC BG

RKD 4/LED2(RD)/60V DC BG

Approvals

UL Recognized

UL Recognized	UL 1059
UL Recognized granted	✓
UL Usegroup C: rated voltage	300 V
UL Usegroup C: rated current	30 A
UL wire cross-section single-core (rigid) AWG, min.	22
UL wire cross-section single-core (rigid) AWG, max.	10
UL wire cross-section stranded AWG, min.	22
UL wire cross-section stranded AWG, max.	10
UL torque	7 Lb In
UL wire material	Cu
UL factory wiring	✓
UL field wiring	✓

2315.2

RKD 4/LED2(RD)/60V DC BG

RKD 4/LED2(RD)/60V DC BG

Media

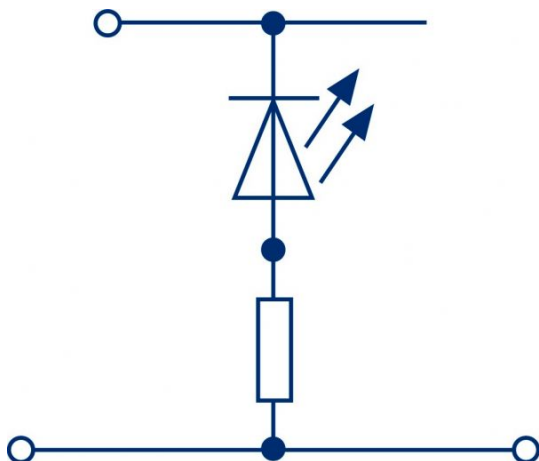

M3

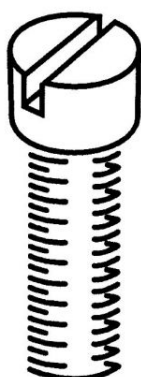

EAC

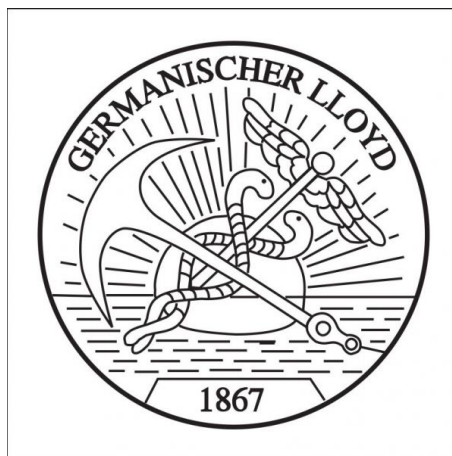

2315.2

RKD 4/LED2(RD)/60V DC BG

RKD 4/LED2(RD)/60V DC BG

Media



2315.2

RKD 4/LED2(RD)/60V DC BG

RKD 4/LED2(RD)/60V DC BG

Accessories

End plate

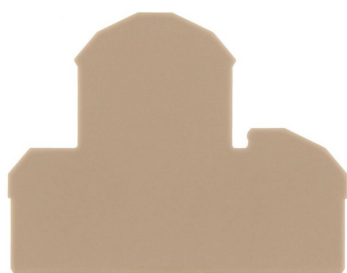

End plate, Width: 1.5 mm, Colour: Beige

In general

Order number	Article designation	GTIN (EAN)	Packaging unit
2101.2	AP 4	4044211151652	20 PC

Insulation plate



Insulation plate, Colour: Beige

In general

Order number	Article designation	GTIN (EAN)	Packaging unit
2566.2	TRS 3	4044211053567	100 PC

2315.2

RKD 4/LED2(RD)/60V DC BG

RKD 4/LED2(RD)/60V DC BG

Accessories

Cross connector



Cross-connector, No. of poles: 10, Mounting type: Can be screwed on, Width: 59.3 mm, Rated cross-section: 4 mm², Colour: natural

In general

Order number	Article designation	GTIN (EAN)	Packaging unit
2090.0	Q 10	4044211048983	10 PC

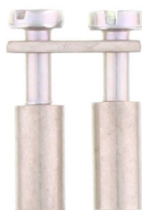

Cross-connector, No. of poles: 2, Mounting type: Can be screwed on, Width: 10.5 mm, Rated cross-section: 4 mm², Colour: natural

In general

Order number	Article designation	GTIN (EAN)	Packaging unit
2087.0	Q 2	4044211048952	50 PC

2315.2

RKD 4/LED2(RD)/60V DC BG

RKD 4/LED2(RD)/60V DC BG

Accessories

Cross connector



Cross-connector, No. of poles: 3, Mounting type: Can be screwed on, Width: 16.6 mm, Rated cross-section: 4 mm², Colour: natural

In general

Order number	Article designation	GTIN (EAN)	Packaging unit
2088.0	Q 3	4044211048969	50 PC



Cross-connector, No. of poles: 4, Mounting type: Can be screwed on, Width: 22.7 mm, Rated cross-section: 4 mm², Colour: natural

In general

Order number	Article designation	GTIN (EAN)	Packaging unit
2089.0	Q 4	4044211048976	20 PC

2315.2

RKD 4/LED2(RD)/60V DC BG

RKD 4/LED2(RD)/60V DC BG

Accessories

End bracket



End stop, Mounting type: Mounting rail TS 35/7.5,
Width: 9.5 mm, Colour: Beige

In general

Order number	Article designation	GTIN (EAN)	Packaging unit
2828.0	ES 35/K/ST	4044211055547	50 PC

Screw driver



Screwdriver with bare blade, Colour: Black-grey

In general

Order number	Article designation	GTIN (EAN)	Packaging unit
1086.0	SDB 0,6x3,5	4044211014797	1 PC

2315.2

RKD 4/LED2(RD)/60V DC BG

RKD 4/LED2(RD)/60V DC BG

Accessories

Quick-marking

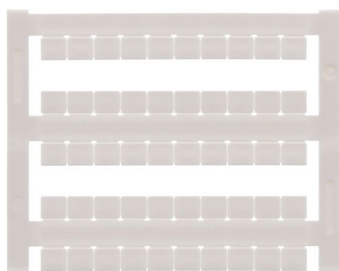

Terminal marker / Pocket Maxicard, Length: 5 mm,
Width: 6 mm, Colour: White

In general

Order number	Article designation	GTIN (EAN)	Packaging unit
4702.7	PMC SB 6/50 WH	4044211089986	500 PC

Jacks



Socket plug, M 2.5, Colour: natural

In general

Order number	Article designation	GTIN (EAN)	Packaging unit
2075.0	STB 8,5/2,3	4044211048839	50 PC

2315.2

RKD 4/LED2(RD)/60V DC BG

RKD 4/LED2(RD)/60V DC BG

Accessories

Test plug



Test plug, Colour: Red

In general

Order number	Article designation	GTIN (EAN)	Packaging unit
2007.0	PS 2,3	4044211048105	20 PC
