

2194.2

TK 2/15/K BG

TK 2/15/K BG

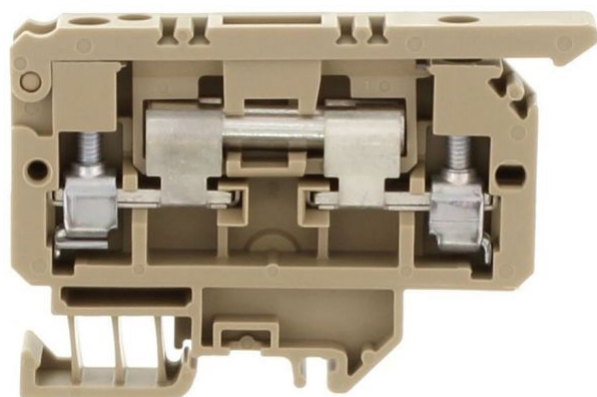

Disconnect terminal, Screw connection, Mounting type: Mounting rail TS 15/5.5, Rated cross-section: 4 mm², Width: 8 mm, Colour: Beige

Business data

Product description	Disconnect terminal
Packaging unit	100
Quantity unit	PC
Weight per piece (not including packaging)	14.6
Weight per piece (including packaging)	15.26
Unit of weight	G
Customs number	85369010
Country of origin	DE

2194.2

TK 2/15/K BG

TK 2/15/K BG

Technical Data

Dimensions

Length	57.5 mm
Width	8 mm
Height TS 15/5.5	38.5 mm

Ratings

Rated voltage	300 V
Rated current	4 A
Rated impulse voltage	6 kV
Overvoltage category	III
Contamination degree	3

2194.2

TK 2/15/K BG

TK 2/15/K BG

Technical Data

Connection data

Connection principle	Screw connection
Connection position	Lateral
Connections	2
Number of terminals per level	2
Number of levels	1
Wire cross-section single-core (rigid) / stranded, min.	0.2 mm ²
Wire cross-section single core (rigid)/stranded, max.	4 mm ²
Wire cross-section stranded, min.	0.2 mm ²
Wire cross-section stranded, max.	4 mm ²
Wire cross-section stranded with wire-end ferrules, min.	0.2 mm ²
Wire cross-section stranded with wire-end ferrules, max.	2.5 mm ²
Wire cross-section AWG, min.	22
Wire cross-section AWG, max.	12
Stripping length	9 mm
Screw head	Slotted
Screw threading	M 3
Tightening torque, min.	0.5 Nm
Tightening torque, max.	1 Nm

2194.2

TK 2/15/K BG

TK 2/15/K BG

Technical Data

Materials

Insulation housing	Polyamide 6.6
Flammability class UL 94	V-2
Working temperature, min.	-40 °C
Working temperature, max.	105 °C

Further technical data

Mounting type	TS 15
Gauge plug acc. to EN 60 947-1	A4
End plate required	✓
Version of lengthwise partition	Swivelling

2194.2

TK 2/15/K BG

TK 2/15/K BG

Approvals

UL Recognized

UL Recognized	UL 1059
UL Recognized granted	✓
UL Usegroup B: rated voltage	600 V
UL Usegroup B: rated current	16 A
UL Usegroup C: rated voltage	600 V
UL Usegroup C: rated current	16 A
UL wire cross-section single-core (rigid) AWG, min.	22
UL wire cross-section single-core (rigid) AWG, max.	12
UL wire cross-section stranded AWG, min.	22
UL wire cross-section stranded AWG, max.	12
UL torque	7 Lb In
UL wire material	Cu
UL factory wiring	✓
UL field wiring	✓

Datasheet

2194.2

TK 2/15/K BG

TK 2/15/K BG

Media

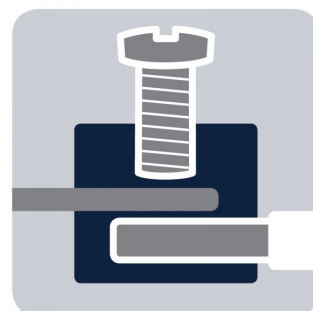

2194.2

TK 2/15/K BG

TK 2/15/K BG

Accessories

End plate



End plate, Width: 1.5 mm, Colour: Beige

In general

Order number	Article designation	GTIN (EAN)	Packaging unit
2046.2	AP SI-1	4044211048518	50 PC

External insulated cross-connector

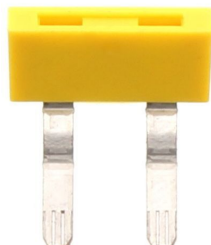

External insulated cross-connector, No. of poles: 2, Mounting type: Plug in, Width: 16.1 mm, Rated current: 27 A; Colour: Yellow

In general

Order number	Article designation	GTIN (EAN)	Packaging unit
2067.0	AQI 2/8/11	4044211048730	50 PC

2194.2

TK 2/15/K BG

TK 2/15/K BG

Accessories

External insulated cross-connector

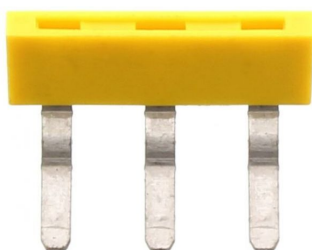

External insulated cross-connector, No. of poles: 3,
Mounting type: Plug in, Width: 24.2 mm, Rated
current: 27 A; Colour: Yellow

In general

Order number	Article designation	GTIN (EAN)	Packaging unit
2068.0	AQI 3/8/11	4044211048747	50 PC

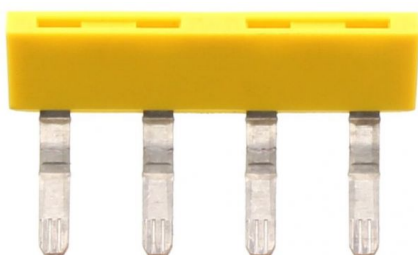

External insulated cross-connector, No. of poles: 4,
Mounting type: Plug in, Width: 32.3 mm, Rated
current: 27 A; Colour: Yellow

In general

Order number	Article designation	GTIN (EAN)	Packaging unit
2069.0	AQI 4/8/11	4044211048754	50 PC

2194.2

TK 2/15/K BG

TK 2/15/K BG

Accessories

End bracket

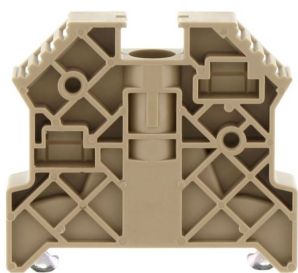

End stop, Mounting type: Mounting rail TS 35/7.5,
Width: 9.5 mm, Colour: Beige

In general

Order number	Article designation	GTIN (EAN)	Packaging unit
2828.0	ES 35/K/ST	4044211055547	50 PC

Contact sleeve



Solid link, Colour: natural

In general

Order number	Article designation	GTIN (EAN)	Packaging unit
2470.0	KH 5	4044211052607	100 PC

2194.2

TK 2/15/K BG

TK 2/15/K BG

Accessories

Quick-marking

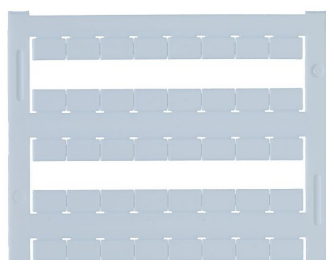

Terminal marker / Pocket Maxicard, Length: 5 mm,
Width: 8 mm, Colour: White

In general

Order number	Article designation	GTIN (EAN)	Packaging unit
9323.7	PMC SB 8/40 WH	4044211129231	400 PC

Screw driver



Screwdriver with bare blade, Colour: Black-grey

In general

Order number	Article designation	GTIN (EAN)	Packaging unit
1086.0	SDB 0,6x3,5	4044211014797	1 PC
