

17116.5

SRK 4/2A SAS BU

SRK 4/2A SAS BU

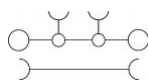
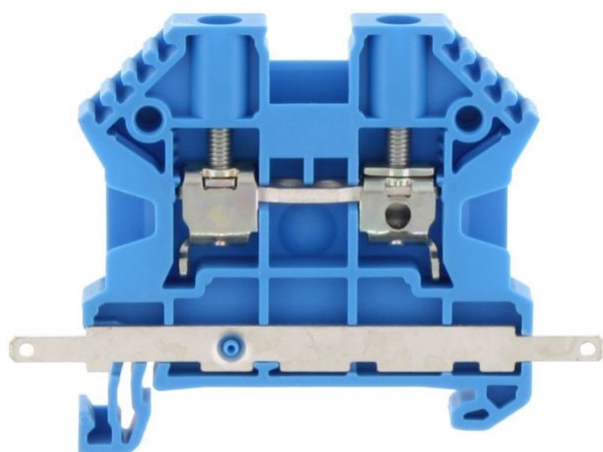

M3



EAC



Feed-through terminal, Screw connection, Mounting type: Mounting rail TS 35/7.5, Rated cross-section: 4 mm², Width: 6 mm, Colour: Blue

Business data

Product description	Feed-through terminal
Packaging unit	80
Quantity unit	PC
Weight per piece (not including packaging)	10.2
Weight per piece (including packaging)	11.1
Unit of weight	G
Customs number	85369010
Country of origin	DE

17116.5

SRK 4/2A SAS BU

SRK 4/2A SAS BU

Technical Data

Dimensions

Length	62.5 mm
--------	---------

Width	6 mm
-------	------

Height TS 35/7.5	47 mm
------------------	-------

Ratings

Rated voltage	400 V
---------------	-------

Rated current	32 A
---------------	------

Current load, max.	41 A
--------------------	------

Rated cross-section	4 mm ²
---------------------	-------------------

Rated impulse voltage	8 kV
-----------------------	------

Overvoltage category	III
----------------------	-----

Contamination degree	3
----------------------	---

17116.5

SRK 4/2A SAS BU

SRK 4/2A SAS BU

Technical Data

Connection data

Connection principle	Screw connection
Connection position	Lateral
Connections	4
Special connection	Flachstecker Faston 2,8 mm
Number of terminals per level	2
Number of levels	1
Wire cross-section single-core (rigid) / stranded, min.	0.2 mm ²
Wire cross-section single core (rigid)/stranded, max.	6 mm ²
Wire cross-section stranded, min.	0.2 mm ²
Wire cross-section stranded, max.	6 mm ²
Wire cross-section stranded with wire-end ferrules, min.	0.2 mm ²
Wire cross-section stranded with wire-end ferrules, max.	4 mm ²
Wire cross-section AWG, min.	26
Wire cross-section AWG, max.	10
Stripping length	10 mm
Screw head	Slotted
Screw threading	M 3
Tightening torque, min.	0.5 Nm
Tightening torque, max.	1 Nm

17116.5

SRK 4/2A SAS BU

SRK 4/2A SAS BU

Technical Data

Materials

Insulation housing	Polyamide 6.6
--------------------	---------------

Flammability class UL 94	V-0
--------------------------	-----

Working temperature, min.	-40 °C
---------------------------	--------

Working temperature, max.	120 °C
---------------------------	--------

Further technical data

Mounting type	Mounting rail TS 35/7,5
---------------	-------------------------

Gauge plug acc. to EN 60 947-1	A4
--------------------------------	----

Number of cross-connection channels	2
-------------------------------------	---

End plate required	✓
--------------------	---

Number of test pick-off options	1
---------------------------------	---

17116.5

SRK 4/2A SAS BU

SRK 4/2A SAS BU

Approvals

Standards and regulations

EAC approval	TR ZU 004/2011
--------------	----------------

EAC approval granted	✓
----------------------	---

German Lloyd approval

GL approval	IEC 60947-7-1
-------------	---------------

GL approval granted	✓
---------------------	---

GL rated voltage	1000 V
------------------	--------

GL rated current	41 A
------------------	------

GL rated cross-section	4 mm ²
------------------------	-------------------

GL rated impulse voltage	8 kV
--------------------------	------

GL environmental category	C
---------------------------	---

17116.5

SRK 4/2A SAS BU

SRK 4/2A SAS BU

Media

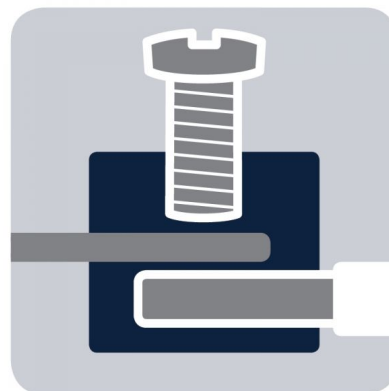
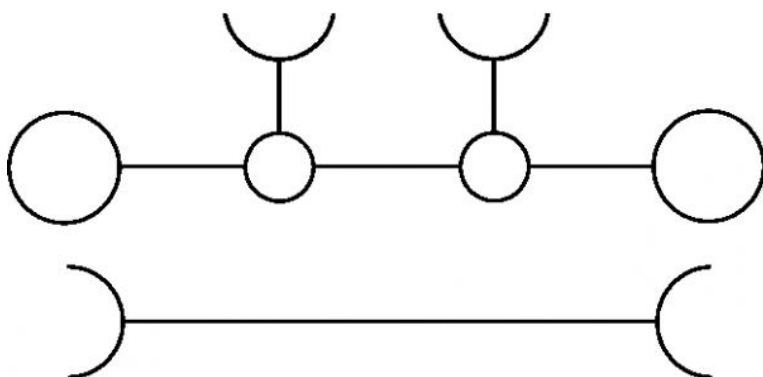

M3

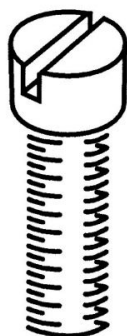

EAC



17116.5

SRK 4/2A SAS BU

SRK 4/2A SAS BU

Accessories

Cover



Cover, Width: 6 mm, Colour: Yellow

In general

Order number	Article designation	GTIN (EAN)	Packaging unit
17296.8	SAD 1/6/B	4044211205447	50 PC

Measurement pick-off terminal



Measurement pick-off terminal, Screw connection, Mounting type: On base, Rated cross-section: 2.5 mm², Width: 5.9 mm, Colour: Beige

In general

Order number	Article designation	GTIN (EAN)	Packaging unit
17120.2	SMAG 4/2,5	4044211172107	10 PC

17116.5

SRK 4/2A SAS BU

SRK 4/2A SAS BU

Accessories

End plate

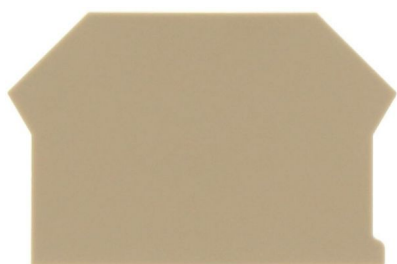

End plate, Width: 1.5 mm, Colour: Beige

In general

Order number	Article designation	GTIN (EAN)	Packaging unit
2001.2	AP 2,5-10	4044211047979	50 PC

End bracket



End stop, Mounting type: Mounting rail TS 35/7.5 and TS 35/15, Width: 8 mm, Colour: Beige

In general

Order number	Article designation	GTIN (EAN)	Packaging unit
17250.2	SES 35	4044211178253	50 PC

17116.5

SRK 4/2A SAS BU

SRK 4/2A SAS BU

Accessories

Insulating cover for cross-connector



Insulating cap, Colour: Yellow

In general

Order number	Article designation	GTIN (EAN)	Packaging unit
17200.8	SQIK 2,5-10	4044211148539	20 PC

Insulated cross connector



Insulated cross-connector, No. of poles: 3, Mounting type: Plug in, Width: 17.4 mm, Rated cross-section: 4 mm², Colour: Yellow

In general

Order number	Article designation	GTIN (EAN)	Packaging unit
17212.8	SQI 4/3	4044211148652	50 PC

17116.5

SRK 4/2A SAS BU

SRK 4/2A SAS BU

Accessories

Quick-marking

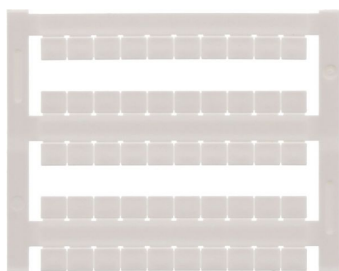

Terminal marker / Pocket Maxicard, Length: 5 mm,
Width: 6 mm, Colour: White

In general

Order number	Article designation	GTIN (EAN)	Packaging unit
4702.7	PMC SB 6/50 WH	4044211089986	500 PC

Screw driver



Screwdriver with bare blade, Colour: Black-grey

In general

Order number	Article designation	GTIN (EAN)	Packaging unit
1086.0	SDB 0,6x3,5	4044211014797	1 PC
