

1579.2

RKD 2,5/35/SV BG

RKD 2,5/35/SV BG

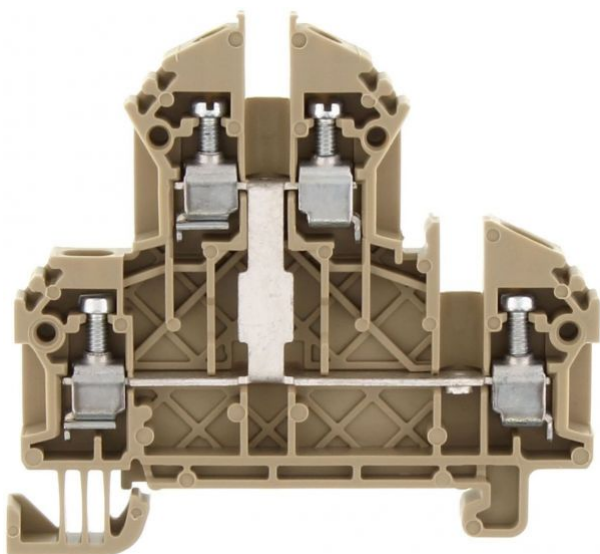

M2.5



Double-level terminal, Screw connection, Mounting type: Mounting rail TS 35/7.5, Rated cross-section: 2.5 mm², Width: 5 mm, Colour: Beige

Business data

Product description	Double-level terminal
Packaging unit	100
Quantity unit	PC
Weight per piece (not including packaging)	10.4
Weight per piece (including packaging)	11.3
Unit of weight	G
Customs number	85369010
Country of origin	DE

1579.2

RKD 2,5/35/SV BG

RKD 2,5/35/SV BG

Technical Data

Dimensions

Length	60.2 mm
Width	5 mm
Height TS 35/7.5	56 mm

Ratings

Rated voltage	500 V
Rated current	24 A
Rated cross-section	2.5 mm ²
Rated impulse voltage	6 kV
Overvoltage category	III
Contamination degree	3

1579.2

RKD 2,5/35/SV BG

RKD 2,5/35/SV BG

Technical Data

Connection data

Connection principle	Screw connection
Connection position	Lateral
Connections	4
Number of terminals per level	2
Number of levels	2
Levels internally bridged	✓
Wire cross-section single-core (rigid) / stranded, min.	0.2 mm ²
Wire cross-section single core (rigid)/stranded, max.	4 mm ²
Wire cross-section stranded, min.	0.2 mm ²
Wire cross-section stranded, max.	4 mm ²
Wire cross-section stranded with wire-end ferrules, min.	0.2 mm ²
Wire cross-section stranded with wire-end ferrules, max.	2.5 mm ²
Wire cross-section AWG, min.	22
Wire cross-section AWG, max.	14
Stripping length	7 mm
Screw head	Slotted
Screw threading	M 2,5
Tightening torque, min.	0.4 Nm
Tightening torque, max.	0.8 Nm

1579.2

RKD 2,5/35/SV BG

RKD 2,5/35/SV BG

Technical Data

Materials

Insulation housing	Polyamide 6.6
--------------------	---------------

Flammability class UL 94	V-2
--------------------------	-----

Working temperature, min.	-40 °C
---------------------------	--------

Working temperature, max.	105 °C
---------------------------	--------

Further technical data

Mounting type	Mounting rail TS 35/7,5
---------------	-------------------------

Gauge plug acc. to EN 60 947-1	A3
--------------------------------	----

Number of cross-connection channels	1
-------------------------------------	---

End plate required	✓
--------------------	---

Number of test pick-off options	1
---------------------------------	---

1579.2

RKD 2,5/35/SV BG

RKD 2,5/35/SV BG

Approvals

CSA approval

CSA approval	C22.2 No 158
CSA approval granted	✓
CSA Usegroup C: rated voltage	300 V
CSA Usegroup C: rated current	20 A
CSA wire cross-section AWG, min.	22
CSA wire cross-section AWG, max.	14
CSA stripping length	7 mm

CSAus approval

CSAus approval	UL 1059
CSAus approval granted	✓
CSAus Usegroup C: rated voltage	300 V
CSAus Usegroup C: rated current	20 A
CSAus wire cross-section AWG, min.	22
CSAus wire cross-section AWG, max.	14
CSAus stripping length	7 mm

1579.2

RKD 2,5/35/SV BG

RKD 2,5/35/SV BG

Approvals

KEMA KEUR approval

KEMA KEUR approval	EN 60947-7-1
KEMA KEUR approval granted	✓
KEMA rated voltage	500 V
KEMA rated current	24 A
KEMA rated impulse voltage	6 kV
KEMA wire cross-section single core (rigid), min.	0.2 mm ²
KEMA wire cross-section single-core (rigid), max.	4 mm ²
KEMA wire cross-section stranded, min.	0.2 mm ²
KEMA wire cross-section stranded, max.	4 mm ²

1579.2

RKD 2,5/35/SV BG

RKD 2,5/35/SV BG

Media

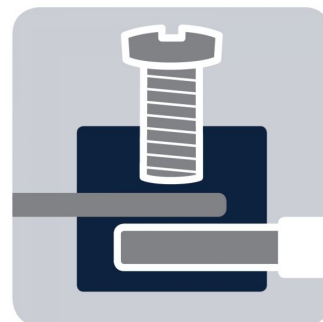
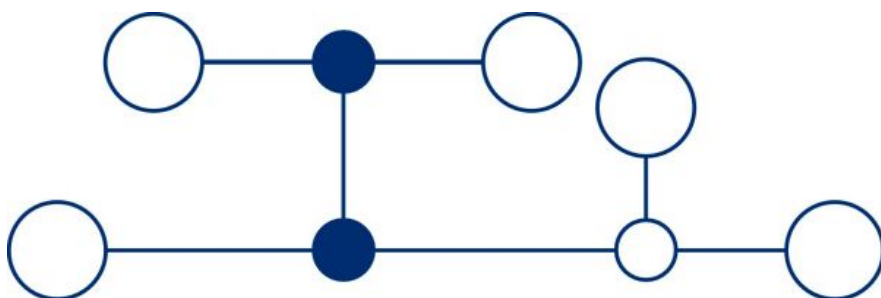

M2.5



1579.2

RKD 2,5/35/SV BG

RKD 2,5/35/SV BG

Accessories

End plate

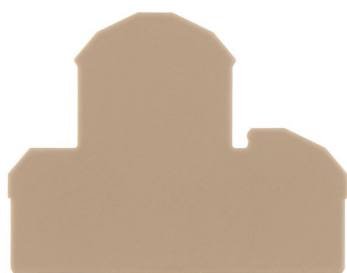

End plate, Width: 1.5 mm, Colour: Beige

In general

Order number	Article designation	GTIN (EAN)	Packaging unit
2101.2	AP 4	4044211151652	20 PC

Insulation plate



Insulation plate, Colour: Beige

In general

Order number	Article designation	GTIN (EAN)	Packaging unit
2566.2	TRS 3	4044211053567	100 PC

1579.2

RKD 2,5/35/SV BG

RKD 2,5/35/SV BG

Accessories

Cross connector



Cross-connector, No. of poles: 10, Mounting type: Can be screwed on, Width: 49.9 mm, Rated cross-section: 2.5 mm², Colour: natural

In general

Order number	Article designation	GTIN (EAN)	Packaging unit
2570.0	Q 10	4044211053604	10 PC

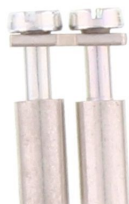

Cross-connector, No. of poles: 2, Mounting type: Can be screwed on, Width: 9.1 mm, Rated cross-section: 2.5 mm², Colour: natural

In general

Order number	Article designation	GTIN (EAN)	Packaging unit
2567.0	Q 2	4044211053574	50 PC

1579.2

RKD 2,5/35/SV BG

RKD 2,5/35/SV BG

Accessories

Cross connector



Cross-connector, No. of poles: 3, Mounting type: Can be screwed on, Width: 14.2 mm, Rated cross-section: 2.5 mm², Colour: natural

In general

Order number	Article designation	GTIN (EAN)	Packaging unit
2568.0	Q 3	4044211053581	50 PC



Cross-connector, No. of poles: 4, Mounting type: Can be screwed on, Width: 19.3 mm, Rated cross-section: 2.5 mm², Colour: natural

In general

Order number	Article designation	GTIN (EAN)	Packaging unit
2569.0	Q 4	4044211053598	20 PC

1579.2

RKD 2,5/35/SV BG

RKD 2,5/35/SV BG

Accessories

End bracket

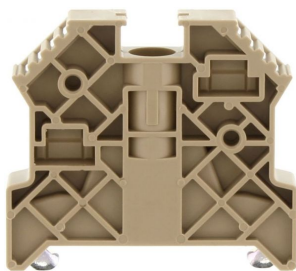

End stop, Mounting type: Mounting rail TS 35/7.5,
Width: 9.5 mm, Colour: Beige

In general

Order number	Article designation	GTIN (EAN)	Packaging unit
2828.0	ES 35/K/ST	4044211055547	50 PC

Test adapter



Test adapter, Length: 37.3 mm, Pitch size: 5 mm,
Colour: Beige

In general

Order number	Article designation	GTIN (EAN)	Packaging unit
2821.0	TAD 5/1/S	4044211055479	10 PC

1579.2

RKD 2,5/35/SV BG

RKD 2,5/35/SV BG

Accessories

Screw driver



Screwdriver with bare blade, Colour: Black-grey

In general

Order number	Article designation	GTIN (EAN)	Packaging unit
1085.0	SDB 0,5x3,0	4044211014643	1 PC

Quick-marking

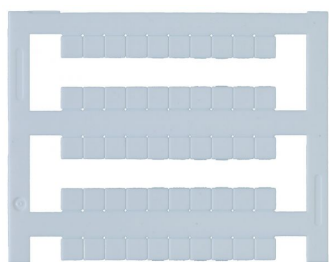

Terminal marker / Pocket Maxicard, Length: 5 mm,
Width: 5 mm, Colour: White

In general

Order number	Article designation	GTIN (EAN)	Packaging unit
4600.7	PMC SB 5/50 WH	4044211088903	500 PC
