



Female socket block, Screw connection, No. of poles: 3, Width: 11.43 mm, Colour: Green

Business data

Article number	<u>13063.1</u>
Article name	PKBZ 1552/3/3,81 GN
GTIN (EAN)	4044211041328
Connector version	Free connector
Packaging unit	50
Quantity unit	PC
Packaging type	Carton
Type of banding	Without
Weight per piece (not including packaging)	2.3 g
Weight per piece (including packaging)	2.75 g
Unit of weight	G
Customs number	85366930
Country of origin	TN
Colour	Green

Technical data

Dimensions

Length	10.4 mm
Width	11.43 mm
Width left	1.905 mm
Width right	1.905 mm
Height	19.1 mm
Pitch	3.81 mm

Ratings

Rated voltage	160 V
Rated current	8 A
Rated cross-section	1.5 mm ²
Rated impulse voltage	2.5 kV
Overvoltage category	III
Contamination degree	3

Connection data

Connection principle	Screw connection
Angle of wire connection/contact	270° (vertically downwards)
Number of plug-in rows	1
No. of poles	3
Contact version	Female connector
Wire cross-section single-core (rigid) / stranded, min.	0.14 mm ²
Wire cross-section single core (rigid)/stranded, max.	1.5 mm ²
Wire cross-section stranded, min.	0.14 mm ²
Wire cross-section stranded, max.	1.5 mm ²
Wire cross-section stranded with wire-end ferrules, min.	0.25 mm ²
Wire cross-section stranded with wire-end ferrules, max.	1 mm ²
Wire cross-section AWG, min.	28
Wire cross-section AWG, max.	16
Stripping length	7 mm
Screw threading	M 2
Torque	0.25 Nm

Technical data

Materials

Insulation housing	Polyamide 6.6
Flammability class UL 94	V-0
Working temperature, min.	-30 °C
Working temperature, max.	105 °C
Clamping element	Brass
Contact spring	Bronze
Screws	Bronze

Further technical data

Storage temperature, min.	-40 °C
Storage temperature, max.	105 °C
Insulation resistance	1*10 ¹³ Ohm x cm
Creepage-current resistance	CTI 600
Glow wire flammability index GWFI	GWFI 850
GWFI after-glow time	30 Sek.
Glow wire ignition temperature GWIT	GWIT 775 °C
GWIT exposure time	5 Sek.
Connection cycles, in compliance with standard	5
Plug-in cycles acc. to standard	100

Environmental Product Compliance

REACH Conform	No
REACH Reference date	2022-06-10
REACH Candidate Substance Note	No
REACH CAS 1 Substance	LEAD
REACH CAS 1 Percent minimal	0.1 %
REACH CAS 1 Percent maximum	4 %
REACH CAS 1 Number	7439-92-1
RoHS Conform	yes
RoHS Exception rule	6c

Approvals

cUL Recognized

cUL approval	CSA 22.2 No.158
cUL Usegroup B: rated voltage	300 V
cUL Usegroup B: rated current	8 A
cUL Usegroup D: rated voltage	300 V
cUL Usegroup D: rated current	8 A
cUL wire cross-section single-core (rigid) AWG, min.	28
cUL wire cross-section single-core (rigid) AWG, max.	16
cUL wire cross-section stranded AWG, min.	28
cUL wire cross-section stranded AWG, max.	16
cUL torque	0.25 Nm
cUL wire material	Cu
cUL Recognized	1

UL Recognized

UL approval	UL 1059
UL Usegroup B: rated voltage	300 V
UL Usegroup B: rated current	8 A
UL Usegroup D: rated voltage	300 V
UL Usegroup D: rated current	8 A
UL wire cross-section single-core (rigid) AWG, min.	28
UL wire cross-section single-core (rigid) AWG, max.	16
UL wire cross-section stranded AWG, min.	28
UL wire cross-section stranded AWG, max.	16
UL torque	2.21 Lb In
UL wire material	Cu
UL factory wiring	1
UL field wiring	1
UL Recognized	1

Approvals

VDE approval

VDE approval	DIN EN 61984
VDE approval granted	yes
VDE rated voltage	160 V
VDE rated current	8 A
VDE rated current wire cross-section rigid, min.	6 A
VDE rated current wire cross-section rigid, max.	8 A
VDE rated current wire cross-section stranded, min.	6 A
VDE rated current wire cross-section stranded, max.	8 A
VDE rated impulse voltage	2.5 kV
VDE wire cross-section rigid, min.	0.5 mm ²
VDE wire cross-section rigid, max.	1.5 mm ²
VDE wire cross-section stranded, min.	0.5 mm ²
VDE wire cross-section stranded, max.	1.5 mm ²
VDE screw threading	M 2
VDE torque	0.25 Nm
VDE overvoltage category	III
VDE contamination degree	3

Media

M2

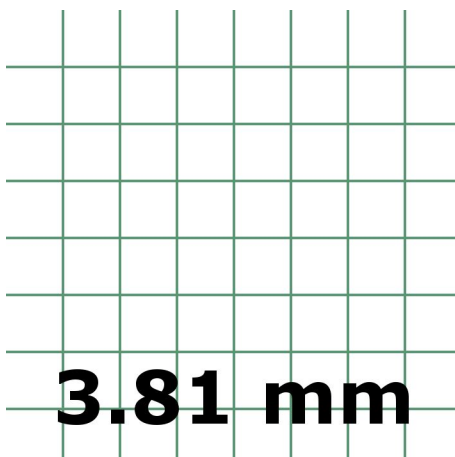
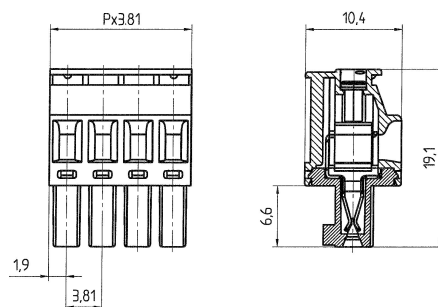

Accessories
