

Male pin block, No. of poles: 14, Width: 73.66 mm, Colour: Green

Business data

Article number	12739.1
Article name	STL 970/14/5,08-V GN
GTIN (EAN)	4044211037598
Connector version	Attached plug-in connector
Packaging unit	50
Quantity unit	PC
Packaging type	Carton
Type of banding	Without
Weight per piece (not including packaging)	16.8 g
Weight per piece (including packaging)	18.8 g
Unit of weight	G
Customs number	85366930
Country of origin	QU
Colour	Green

Technical data

Dimensions

Length	23.5 mm
Length of the pin	3.9 mm
Width	73.66 mm
Width left	2.54 mm
Width right	5.08 mm
Height	22 mm
Drill hole diameter	1.4 mm
Diameter of connecting pin	1 mm
Pitch	5.08 mm

Ratings

Rated voltage	250 V
Rated current	12 A
Rated impulse voltage	4 kV
Overvoltage category	III
Contamination degree	3

Connection data

Angle of PCB/contact	90° (vertically upwards)
Number of plug-in rows	2
No. of poles	14

Materials

Insulation housing	Polybutylene terephthalate
Flammability class UL 94	V-0
Working temperature, min.	-30 °C
Working temperature, max.	105 °C
Contact pin	Copper alloy

Technical data

Further technical data

Storage temperature, min.	-40 °C
Storage temperature, max.	105 °C
Insulation resistance	1*10 ¹³ Ohm x cm
Creepage-current resistance	CTI 175
Glow wire flammability index GWFI	GWFI 850
GWFI after-glow time	30 Sek.
Glow wire ignition temperature GWIT	GWIT 775 °C
GWIT exposure time	5 Sek.
Plug-in cycles acc. to standard	100
Recommended wave soldering temperature	265 °C
Recommended wave soldering duration, min.	3 Sek.
Recommended wave soldering duration, max.	4 Sek.

Environmental Product Compliance

REACH Conform	yes
REACH Reference date	2022-06-10
REACH Candidate Substance Note	No
RoHS Conform	yes

Approvals

cUL Recognized

cUL approval	CSA 22.2 No.158
cUL Usegroup B: rated voltage	300 V
cUL Usegroup B: rated current	15 A
cUL Usegroup C: rated voltage	150 V
cUL Usegroup C: rated current	15 A
cUL Usegroup D: rated voltage	300 V
cUL Usegroup D: rated current	10 A
cUL wire material	Cu
cUL Recognized	1

UL Recognized

UL approval	UL 1059
UL Usegroup B: rated voltage	300 V
UL Usegroup B: rated current	15 A
UL Usegroup C: rated voltage	150 V
UL Usegroup C: rated current	15 A
UL Usegroup D: rated voltage	300 V
UL Usegroup D: rated current	10 A
UL wire material	Cu
UL factory wiring	1
UL Recognized	1

VDE approval

VDE approval	DIN EN 61984
VDE approval granted	yes
VDE rated voltage	250 V
VDE rated current	12 A
VDE rated impulse voltage	4 kV
VDE overvoltage category	III
VDE contamination degree	3

Media

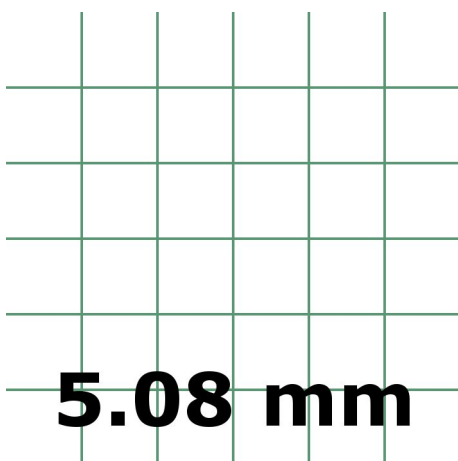
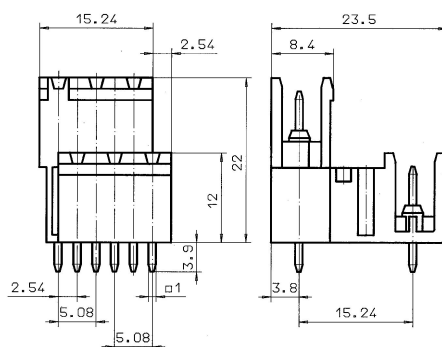

Accessories
