



PCB terminal, Screw connection, No. of poles: 21, Width: 107.28 mm, Colour: Dark grey

Business data

| | |
|--|---------------------|
| Article number | 12629.4 |
| Article name | PK 700/21/5,08-V DG |
| GTIN (EAN) | 4044211035815 |
| Packaging unit | 50 |
| Quantity unit | PC |
| Packaging type | Carton |
| Type of banding | Without |
| Weight per piece (not including packaging) | 33.4 g |
| Weight per piece (including packaging) | 35.15 g |
| Unit of weight | G |
| Customs number | 85369010 |
| Country of origin | QU |
| Prio-Article | 12629.1 |

Technical data

Dimensions

| | |
|----------------------------|-----------|
| Length | 10.5 mm |
| Length of the pin | 4 mm |
| Width | 107.28 mm |
| Width left | 3.14 mm |
| Width right | 2.54 mm |
| Height | 19 mm |
| Drill hole diameter | 1.3 mm |
| Diameter of connecting pin | 0.9 mm |
| Pitch | 5.08 mm |

Ratings

| | |
|-----------------------|---------------------|
| Rated voltage | 250 V |
| Rated current | 24 A |
| Rated cross-section | 2.5 mm ² |
| Rated impulse voltage | 2 kV |
| Overvoltage category | III |
| Contamination degree | 3 |

Technical data

Connection data

| | |
|---|----------------------|
| Connection principle | Screw connection |
| Connection type of PCB | Solder connection |
| Type of attachment to circuit board | Connecting contact |
| Angle of PCB/wire connection | 0°/180° (horizontal) |
| No. of poles | 21 |
| Number of levels | 1 |
| Wire cross-section single-core (rigid) / stranded, min. | 0.2 mm ² |
| Wire cross-section single core (rigid)/stranded, max. | 4 mm ² |
| Wire cross-section stranded, min. | 0.2 mm ² |
| Wire cross-section stranded, max. | 2.5 mm ² |
| Wire cross-section stranded with wire-end ferrules,min. | 0.25 mm ² |
| Wire cross-section stranded with wire-end ferrules,max. | 2.5 mm ² |
| Wire cross-section AWG, min. | 30 |
| Wire cross-section AWG, max. | 12 |
| Stripping length | 8 mm |
| Screw threading | M 3 |
| Torque | 0.5 Nm |

Materials

| | |
|---------------------------|---------------|
| Insulation housing | Polyamide 6.6 |
| Flammability class UL 94 | V-0 |
| Working temperature, min. | -30 °C |
| Working temperature, max. | 105 °C |
| Clamping element | Brass |
| Screws | Steel |
| Soldering lug | Copper alloy |

Technical data

Further technical data

| | |
|--|-----------------------------|
| Storage temperature, min. | -40 °C |
| Storage temperature, max. | 105 °C |
| Insulation resistance | 1*10 ¹³ Ohm x cm |
| Creepage-current resistance | CTI 600 |
| Glow wire flammability index GWFI | GWFI 850 |
| GWFI after-glow time | 30 Sek. |
| Glow wire ignition temperature GWIT | GWIT 775 °C |
| GWIT exposure time | 5 Sek. |
| Connection cycles, in compliance with standard | 5 |
| Recommended wave soldering temperature | 265 °C |
| Recommended wave soldering duration, min. | 3 Sek. |
| Recommended wave soldering duration, max. | 4 Sek. |

Environmental Product Compliance

| | |
|--------------------------------|------------|
| REACH Conform | No |
| REACH Reference date | 2022-06-10 |
| REACH Candidate Substance Note | No |
| REACH CAS 1 Substance | LEAD |
| REACH CAS 1 Percent minimal | 0.1 % |
| REACH CAS 1 Percent maximum | 4 % |
| REACH CAS 1 Number | 7439-92-1 |
| RoHS Conform | yes |
| RoHS Exception rule | 6c |

Approvals

cUL Recognized

| | |
|--|-----------------|
| cUL approval | C22.2 No 158 |
| cUL Usegroup B: rated voltage | 300 V |
| cUL Usegroup B: rated current | 15 A |
| cUL Usegroup C: rated voltage | 300 V |
| cUL Usegroup C: rated current | 15 A |
| cUL Usegroup D: rated voltage | 300 V |
| cUL Usegroup D: rated current | 15 A |
| cUL wire cross-section single-core (rigid) AWG, min. | 22 |
| cUL wire cross-section single-core (rigid) AWG, max. | 12 |
| cUL wire cross-section stranded AWG, min. | 22 |
| cUL wire cross-section stranded AWG, max. | 12 |
| cUL torque | 0.4499999881 Nm |
| cUL wire material | Cu |
| cUL Recognized | 1 |

UL Recognized

| | |
|---|---------|
| UL approval | UL 1059 |
| UL Usegroup B: rated voltage | 300 V |
| UL Usegroup B: rated current | 15 A |
| UL Usegroup C: rated voltage | 300 V |
| UL Usegroup C: rated current | 15 A |
| UL Usegroup D: rated voltage | 300 V |
| UL Usegroup D: rated current | 15 A |
| UL wire cross-section single-core (rigid) AWG, min. | 22 |
| UL wire cross-section single-core (rigid) AWG, max. | 12 |
| UL wire cross-section stranded AWG, min. | 22 |
| UL wire cross-section stranded AWG, max. | 12 |
| UL torque | 4 Lb In |
| UL wire material | Cu |
| UL factory wiring | 1 |
| UL field wiring | 1 |
| UL Recognized | 1 |

Approvals

VDE approval

| | |
|---|---------------------|
| VDE approval | DIN EN 60998 |
| VDE approval granted | yes |
| VDE rated voltage | 250 V |
| VDE rated current | 24 A |
| VDE rated current wire cross-section rigid, max. | 24 A |
| VDE rated current wire cross-section stranded, max. | 24 A |
| VDE rated impulse voltage | 2 kV |
| VDE wire cross-section rigid, min. | 0.5 mm ² |
| VDE wire cross-section rigid, max. | 4 mm ² |
| VDE wire cross-section stranded, min. | 0.5 mm ² |
| VDE wire cross-section stranded, max. | 2.5 mm ² |
| VDE screw threading | M 3 |
| VDE torque | 0.5 Nm |
| VDE overvoltage category | III |
| VDE contamination degree | 3 |

Media

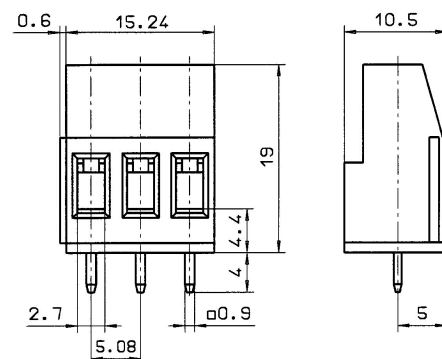

M3

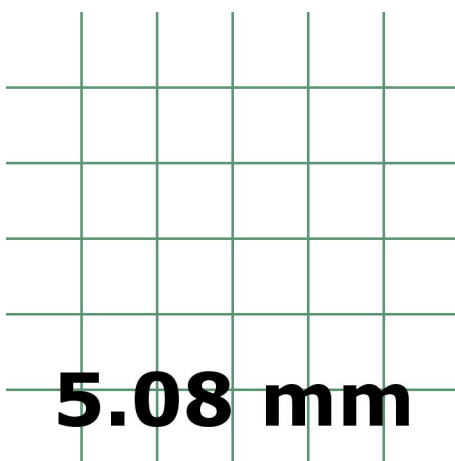

Accessories
