

1210.2

RK 2,5-4/ZR BG

RK 2,5-4/ZR BG

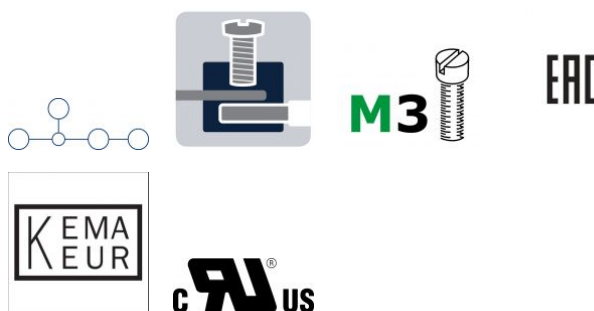
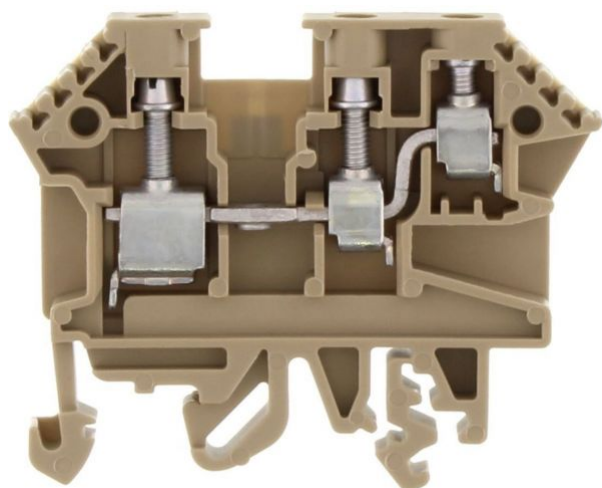

Feed-through terminal, Screw connection, Mounting type: Mounting rail TS 35/7.5 and TS 32, Rated cross-section: 4 mm², Width: 6 mm, Colour: Beige

Business data

Product description	Feed-through terminal
Packaging unit	100
Quantity unit	PC
Weight per piece (not including packaging)	11.4
Weight per piece (including packaging)	12.33
Unit of weight	G
Customs number	85369010
Country of origin	DE

1210.2

RK 2,5-4/ZR BG

RK 2,5-4/ZR BG

Technical Data

Dimensions

Length	57.5 mm
--------	---------

Width	6 mm
-------	------

Height TS 35/7.5	47 mm
------------------	-------

Height TS 32	51.5 mm
--------------	---------

Ratings

Rated voltage	500 V
---------------	-------

Rated current	24 A
---------------	------

Rated cross-section	4 mm ²
---------------------	-------------------

Rated impulse voltage	6 kV
-----------------------	------

Overvoltage category	III
----------------------	-----

Contamination degree	3
----------------------	---

1210.2

RK 2,5-4/ZR BG

RK 2,5-4/ZR BG

Technical Data

Connection data

Connection principle	Screw connection
Connection position	Lateral
Connections	3
Number of terminals per level	2
Number of levels	1
Wire cross-section single-core (rigid) / stranded, min.	0.2 mm ²
Wire cross-section single core (rigid)/stranded, max.	4 mm ²
Wire cross-section stranded, min.	0.2 mm ²
Wire cross-section stranded, max.	6 mm ²
Wire cross-section stranded with wire-end ferrules, min.	0.2 mm ²
Wire cross-section stranded with wire-end ferrules, max.	2.5 mm ²
Wire cross-section AWG, min.	22
Wire cross-section AWG, max.	12
Stripping length	12 mm
Screw head	Slotted
Screw threading	M 3
Tightening torque, min.	0.5 Nm
Tightening torque, max.	1 Nm

1210.2

RK 2,5-4/ZR BG

RK 2,5-4/ZR BG

Technical Data

Materials

Insulation housing	Polyamide 6.6
--------------------	---------------

Flammability class UL 94	V-2
--------------------------	-----

Working temperature, min.	-40 °C
---------------------------	--------

Working temperature, max.	105 °C
---------------------------	--------

Further technical data

Mounting type	Mounting rail TS 35/7.5 and TS 32
---------------	-----------------------------------

Gauge plug acc. to EN 60 947-1	A4
--------------------------------	----

Number of cross-connection channels	1
-------------------------------------	---

End plate required	✓
--------------------	---

Number of test pick-off options	1
---------------------------------	---

1210.2

RK 2,5-4/ZR BG

RK 2,5-4/ZR BG

Approvals

Standards and regulations

EAC approval	TR ZU 004/2011
--------------	----------------

EAC approval granted	✓
----------------------	---

cUL Recognized

cUL Recognized	C22.2 No 158
----------------	--------------

cUL Recognized	✓
----------------	---

cUL Usegroup B: rated voltage	600 V
-------------------------------	-------

cUL Usegroup B: rated current	30 A
-------------------------------	------

cUL Usegroup C: rated voltage	600 V
-------------------------------	-------

cUL Usegroup C: rated current	30 A
-------------------------------	------

cUL wire cross-section single-core (rigid) AWG, min.	22
--	----

cUL wire cross-section single-core (rigid) AWG, max.	10
--	----

cUL wire cross-section stranded AWG, min.	22
---	----

cUL wire cross-section stranded AWG, max.	10
---	----

cUL torque	7 Nm
------------	------

cUL wire material	Cu
-------------------	----

1210.2

RK 2,5-4/ZR BG

RK 2,5-4/ZR BG

Approvals

KEMA KEUR approval

KEMA KEUR approval	EN 60947-7-1
KEMA KEUR approval granted	✓
KEMA rated voltage	800 V
KEMA rated current	32 A
KEMA rated impulse voltage	6 kV
KEMA wire cross-section single core (rigid), min.	0.2 mm ²
KEMA wire cross-section single-core (rigid), max.	6 mm ²
KEMA wire cross-section stranded, min.	0.2 mm ²
KEMA wire cross-section stranded, max.	6 mm ²
KEMA torque, min.	0.5 Nm
KEMA torque, max.	1 Nm

1210.2

RK 2,5-4/ZR BG

RK 2,5-4/ZR BG

Approvals

UL Recognized

UL Recognized	UL 1059
UL Recognized granted	✓
UL Usegroup B: rated voltage	600 V
UL Usegroup B: rated current	30 A
UL Usegroup C: rated voltage	600 V
UL Usegroup C: rated current	30 A
UL wire cross-section single-core (rigid) AWG, min.	22
UL wire cross-section single-core (rigid) AWG, max.	10
UL wire cross-section stranded AWG, min.	22
UL wire cross-section stranded AWG, max.	10
UL torque	7 Lb In
UL wire material	Cu
UL factory wiring	✓
UL field wiring	✓

1210.2

RK 2,5-4/ZR BG

RK 2,5-4/ZR BG

Media

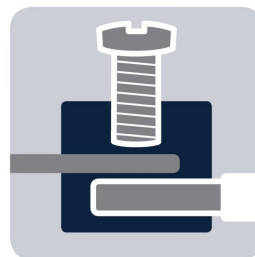
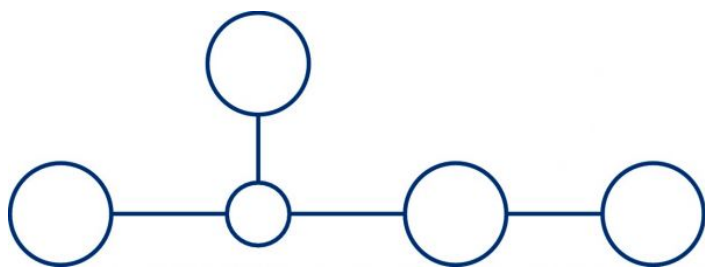

M3



EAC



1210.2

RK 2,5-4/ZR BG

RK 2,5-4/ZR BG

Accessories

End plate



End plate, Width: 1.5 mm, Colour: Beige

In general

Order number	Article designation	GTIN (EAN)	Packaging unit
2574.2	AP 2,5-4/R	4044211053659	50 PC

End bracket



End stop, Mounting type: Mounting rail TS 35/7.5,
Width: 9.5 mm, Colour: Beige

In general

Order number	Article designation	GTIN (EAN)	Packaging unit
2828.0	ES 35/K/ST	4044211055547	50 PC

1210.2

RK 2,5-4/ZR BG

RK 2,5-4/ZR BG

Accessories

Cross connector



Cross-connector, No. of poles: 10, Mounting type: Can be screwed on, Width: 59.7 mm, Rated cross-section: 4 mm², Colour: natural

In general

Order number	Article designation	GTIN (EAN)	Packaging unit
2022.0	Q 10	4044211048259	10 PC

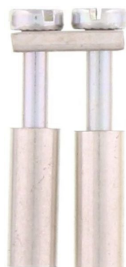

Cross-connector, No. of poles: 2, Mounting type: Can be screwed on, Width: 10.9 mm, Rated cross-section: 4 mm², Colour: natural

In general

Order number	Article designation	GTIN (EAN)	Packaging unit
2019.0	Q 2	4044211048228	50 PC

1210.2

RK 2,5-4/ZR BG

RK 2,5-4/ZR BG

Accessories

Cross connector

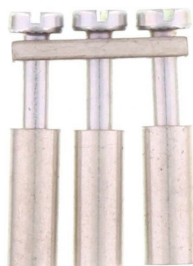

Cross-connector, No. of poles: 3, Mounting type: Can be screwed on, Width: 17 mm, Rated cross-section: 4 mm², Colour: natural

In general

Order number	Article designation	GTIN (EAN)	Packaging unit
2020.0	Q 3	4044211048235	50 PC

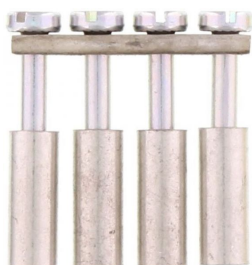

Cross-connector, No. of poles: 4, Mounting type: Can be screwed on, Width: 23.1 mm, Rated cross-section: 4 mm², Colour: natural

In general

Order number	Article designation	GTIN (EAN)	Packaging unit
2021.0	Q 4	4044211048242	20 PC

1210.2

RK 2,5-4/ZR BG

RK 2,5-4/ZR BG

Accessories

Insulated cross connector



Insulated cross-connector, No. of poles: 10, Mounting type: Can be screwed on, Width: 59.7 mm, Colour: Yellow

In general

Order number	Article designation	GTIN (EAN)	Packaging unit
2743.2	QI 10	4044211054830	10 PC



Insulated cross-connector, No. of poles: 2, Mounting type: Can be screwed on, Width: 10.4 mm, Colour: Yellow

In general

Order number	Article designation	GTIN (EAN)	Packaging unit
2740.2	QI 2	4044211054809	50 PC

1210.2

RK 2,5-4/ZR BG

RK 2,5-4/ZR BG

Accessories

Insulated cross connector

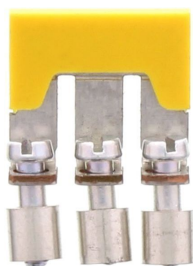

Insulated cross-connector, No. of poles: 3, Mounting type: Can be screwed on, Width: 16.5 mm, Colour: Yellow

In general

Order number	Article designation	GTIN (EAN)	Packaging unit
2741.2	QI 3	4044211054816	50 PC

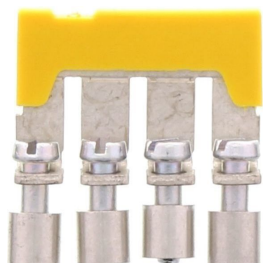

Insulated cross-connector, No. of poles: 4, Mounting type: Can be screwed on, Width: 21.9 mm, Colour: Yellow

In general

Order number	Article designation	GTIN (EAN)	Packaging unit
2742.2	QI 4	4044211054823	20 PC

1210.2

RK 2,5-4/ZR BG

RK 2,5-4/ZR BG

Accessories

Quick-marking

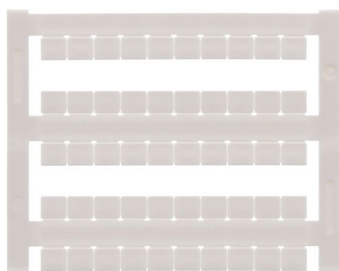

Terminal marker / Pocket Maxicard, Length: 5 mm,
Width: 6 mm, Colour: White

In general

Order number	Article designation	GTIN (EAN)	Packaging unit
4702.7	PMC SB 6/50 WH	4044211089986	500 PC

Screw driver



Screwdriver with bare blade, Colour: Black-grey

In general

Order number	Article designation	GTIN (EAN)	Packaging unit
1086.0	SDB 0,6x3,5	4044211014797	1 PC

1210.2

RK 2,5-4/ZR BG

RK 2,5-4/ZR BG

Accessories

Test adapter



Test adapter, Length: 37.3 mm, Pitch size: 6 mm,
Colour: Beige

In general

Order number	Article designation	GTIN (EAN)	Packaging unit
2813.0	TA 6/1/ST	4044211055400	10 PC

Insulation plate



Insulation plate, Colour: Beige

In general

Order number	Article designation	GTIN (EAN)	Packaging unit
2003.2	TRS 1	4044211048068	100 PC
