

Male pin block, No. of poles: 4, Width: 15.4 mm, Colour: Green

Business data

| | |
|--|----------------------------|
| Article number | 11879.1 |
| Article name | STL 1550/4/3,50-V-G GN |
| GTIN (EAN) | 4044211026318 |
| Connector version | Attached plug-in connector |
| Packaging unit | 50 |
| Quantity unit | PC |
| Packaging type | Carton |
| Type of banding | Without |
| Weight per piece (not including packaging) | 0.8 g |
| Weight per piece (including packaging) | 1.25 g |
| Unit of weight | G |
| Customs number | 85366930 |
| Country of origin | TN |
| Colour | Green |

Technical data

Dimensions

| | |
|----------------------------|---------|
| Length | 7 mm |
| Length of the pin | 3.4 mm |
| Width | 15.4 mm |
| Width left | 2.45 mm |
| Width right | 2.45 mm |
| Height | 9.2 mm |
| Drill hole diameter | 1.2 mm |
| Diameter of connecting pin | 0.8 mm |
| Pitch | 3.5 mm |

Ratings

| | |
|-----------------------|--------|
| Rated voltage | 160 V |
| Rated current | 10 A |
| Rated impulse voltage | 2.5 kV |
| Overvoltage category | III |
| Contamination degree | 3 |

Connection data

| | |
|------------------------|--------------------------|
| Angle of PCB/contact | 90° (vertically upwards) |
| Number of plug-in rows | 1 |
| No. of poles | 4 |

Materials

| | |
|---------------------------|---------------|
| Insulation housing | Polyamide 6.6 |
| Flammability class UL 94 | V-0 |
| Working temperature, min. | -30 °C |
| Working temperature, max. | 105 °C |
| Contact pin | Copper alloy |

Technical data

Further technical data

| | |
|---|-----------------------------|
| Storage temperature, min. | -40 °C |
| Storage temperature, max. | 105 °C |
| Insulation resistance | 1*10 ¹³ Ohm x cm |
| Creepage-current resistance | CTI 600 |
| Glow wire flammability index GWFI | GWFI 850 |
| GWFI after-glow time | 30 Sek. |
| Glow wire ignition temperature GWIT | GWIT 775 °C |
| GWIT exposure time | 5 Sek. |
| Plug-in cycles acc. to standard | 100 |
| Recommended wave soldering temperature | 265 °C |
| Recommended wave soldering duration, min. | 3 Sek. |
| Recommended wave soldering duration, max. | 4 Sek. |

Environmental Product Compliance

| | |
|--------------------------------|------------|
| REACH Conform | yes |
| REACH Reference date | 2022-06-10 |
| REACH Candidate Substance Note | No |
| RoHS Conform | yes |

Approvals

cUL Recognized

| | |
|-------------------------------|-----------------|
| cUL approval | CSA 22.2 No.158 |
| cUL Usegroup B: rated voltage | 300 V |
| cUL Usegroup B: rated current | 10 A |
| cUL Usegroup D: rated voltage | 300 V |
| cUL Usegroup D: rated current | 10 A |
| cUL wire material | Cu |
| cUL Recognized | 1 |

UL Recognized

| | |
|------------------------------|---------|
| UL approval | UL 1059 |
| UL Usegroup B: rated voltage | 300 V |
| UL Usegroup B: rated current | 10 A |
| UL Usegroup D: rated voltage | 300 V |
| UL Usegroup D: rated current | 10 A |
| UL wire material | Cu |
| UL factory wiring | 1 |
| UL Recognized | 1 |

VDE approval

| | |
|---------------------------|--------------|
| VDE approval | DIN EN 61984 |
| VDE approval granted | yes |
| VDE rated voltage | 160 V |
| VDE rated current | 10 A |
| VDE rated impulse voltage | 2.5 kV |
| VDE overvoltage category | III |
| VDE contamination degree | 3 |

Media

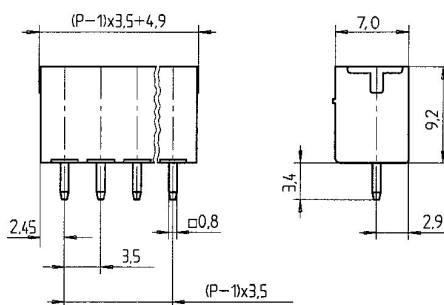
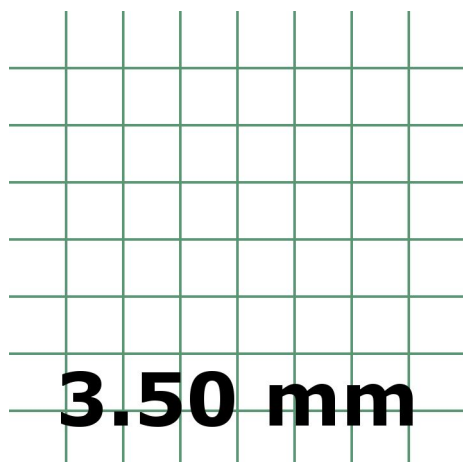

Accessories
