

11141.1

PZK 3101/21/5,00/5,08-WD GN

PZK 3101/21/5,00/5,08-WD GN

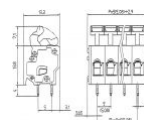
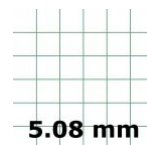
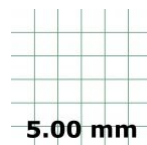
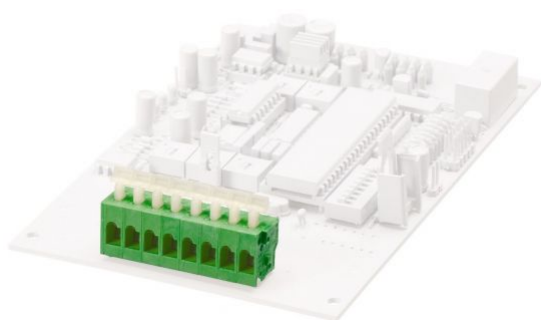

PCB terminal, Tension-spring connection, No. of poles: 21, Width: 107.9 mm, Colour: Green

11141.1

PZK 3101/21/5,00/5,08-WD GN

PZK 3101/21/5,00/5,08-WD GN

Media

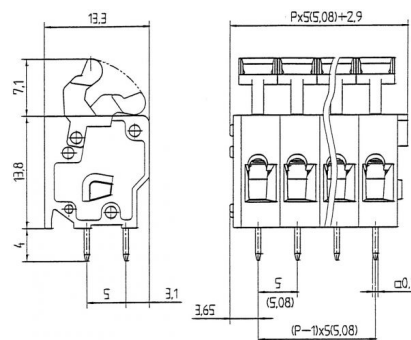
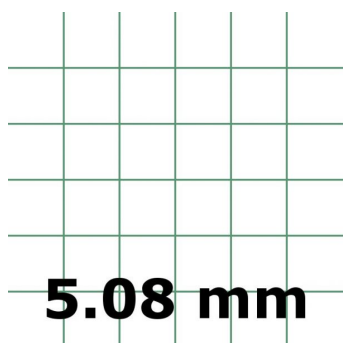
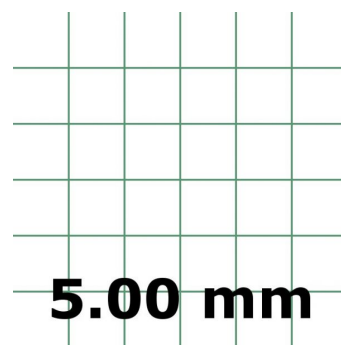

CRV[®] US

