

11133.0

PZK 3101/13/5,00/5,08-WD LG

PZK 3101/13/5,00/5,08-WD LG

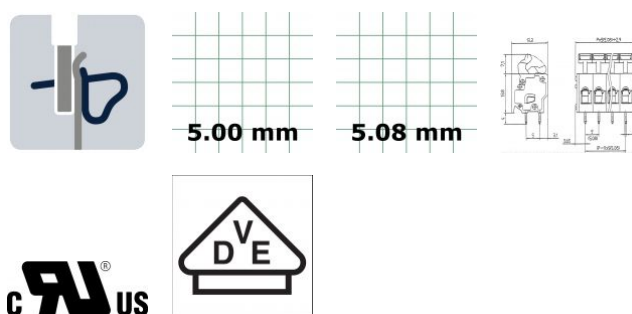

PCB terminal, Tension-spring connection, No. of poles: 13, Width: 67.9 mm, Colour: Pebble grey

Business data

Packaging unit	50
Quantity unit	PC
Packaging type	Carton
Type of banding	Without
Weight per piece (not including packaging)	16.25
Weight per piece (including packaging)	17.45
Unit of weight	G
Customs number	85369010
Country of origin	QU

11133.0

PZK 3101/13/5,00/5,08-WD LG

PZK 3101/13/5,00/5,08-WD LG

Technical Data

Dimensions

Length	13.3 mm
Length of the pin	4 mm
Width	67.9 mm
Width left	3.65 mm
Width right	4.25 mm
Height	13.8 mm
Drill hole diameter	1.1 mm
Diameter of connecting pin	0.7 mm
Pitch	5 mm

Ratings

Rated voltage	250 V
Rated current	24 A
Rated cross-section	2.5 mm ²
Rated impulse voltage	2 kV
Overvoltage category	III
Contamination degree	3

11133.0

PZK 3101/13/5,00/5,08-WD LG

PZK 3101/13/5,00/5,08-WD LG

Technical Data

Connection data

Connection principle	Tension-spring connection
Connection type of PCB	Solder connection
Type of attachment to circuit board	Connecting contact
Angle of PCB/wire connection	0°/180° (horizontal)
No. of poles	13
Number of levels	1
Wire cross-section single-core (rigid) / stranded, min.	0.14 mm ²
Wire cross-section single core (rigid)/stranded, max.	2.5 mm ²
Wire cross-section stranded, min.	0.14 mm ²
Wire cross-section stranded, max.	2.5 mm ²
Wire cross-section stranded with wire-end ferrules, min.	0.14 mm ²
Wire cross-section stranded with wire-end ferrules, max.	1.5 mm ²
Wire cross-section AWG, min.	28
Wire cross-section AWG, max.	14
Stripping length	6 mm

11133.0

PZK 3101/13/5,00/5,08-WD LG

PZK 3101/13/5,00/5,08-WD LG

Technical Data

Materials

Insulation housing	Polyamide 6.6
Flammability class UL 94	V-0
Working temperature, min.	-30 °C
Working temperature, max.	105 °C
Tension spring	Stainless steel
Soldering lug	Copper alloy

Further technical data

Storage temperature, min.	-40 °C
Storage temperature, max.	105 °C
Insulation resistance	1*10 ¹³ Ohm x cm
Creepage-current resistance	CTI 600
Glow wire flammability index GWFI	GWFI 850
GWFI after-glow time	30 Sek.
Glow wire ignition temperature GWIT	GWIT 775 °C
GWIT exposure time	5 Sek.
Connection cycles, in compliance with standard	10
Recommended wave soldering temperature	265 °C
Recommended wave soldering duration, min.	3 Sek.

11133.0

PZK 3101/13/5,00/5,08-WD LG

PZK 3101/13/5,00/5,08-WD LG

Technical Data

Further technical data

Recommended wave soldering duration, max.	4 Sek.
---	--------

11133.0

PZK 3101/13/5,00/5,08-WD LG

PZK 3101/13/5,00/5,08-WD LG

Approvals

cUL Recognized

cUL Recognized	CSA 22.2 No.158
cUL Recognized	✓
cUL Usegroup B: rated voltage	300 V
cUL Usegroup B: rated current	16 A
cUL Usegroup D: rated voltage	300 V
cUL Usegroup D: rated current	10 A
cUL wire cross-section single-core (rigid) AWG, min.	28
cUL wire cross-section single-core (rigid) AWG, max.	14
cUL wire cross-section stranded AWG, min.	28
cUL wire cross-section stranded AWG, max.	14
cUL wire material	Cu

11133.0

PZK 3101/13/5,00/5,08-WD LG

PZK 3101/13/5,00/5,08-WD LG

Approvals

UL Recognized

UL Recognized	UL 1059
UL Recognized granted	✓
UL Usegroup B: rated voltage	300 V
UL Usegroup B: rated current	16 A
UL Usegroup D: rated voltage	300 V
UL Usegroup D: rated current	10 A
UL wire cross-section single-core (rigid) AWG, min.	28
UL wire cross-section single-core (rigid) AWG, max.	14
UL wire cross-section stranded AWG, min.	28
UL wire cross-section stranded AWG, max.	14
UL wire material	Cu
UL factory wiring	✓
UL field wiring	✓

11133.0

PZK 3101/13/5,00/5,08-WD LG

PZK 3101/13/5,00/5,08-WD LG

Approvals

VDE approval

VDE approval	DIN EN 60998
VDE approval granted	✓
VDE rated voltage	250 V
VDE rated current	24 A
VDE rated current wire cross-section rigid, max.	24 A
VDE rated current wire cross-section stranded, max.	24 A
VDE rated impulse voltage	2 kV
VDE wire cross-section rigid, min.	0.5 mm ²
VDE wire cross-section rigid, max.	2.5 mm ²
VDE wire cross-section stranded, min.	0.5 mm ²
VDE wire cross-section stranded, max.	2.5 mm ²
VDE overvoltage category	III
VDE contamination degree	3

11133.0

PZK 3101/13/5,00/5,08-WD LG

PZK 3101/13/5,00/5,08-WD LG

Media



5.00 mm

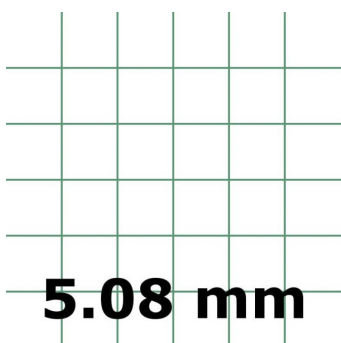

5.08 mm

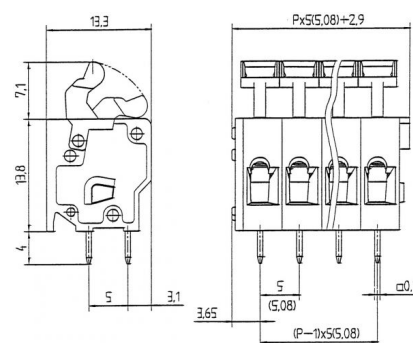

CRV[®] US

