

Illustrations

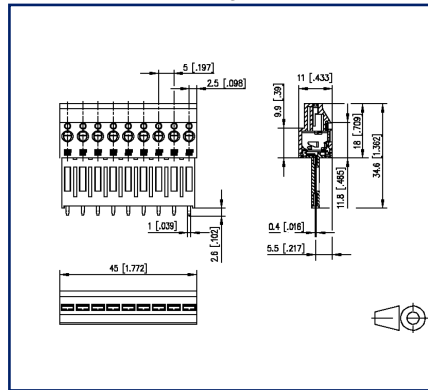

Dimensional drawing



Drill pattern

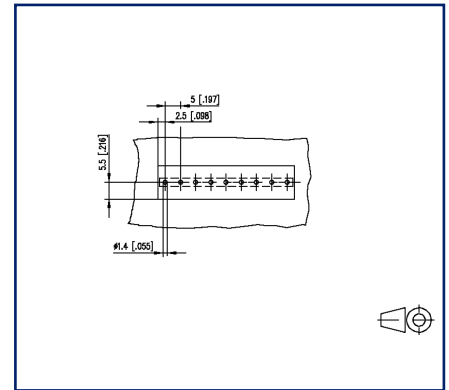

See enlarged drawings at the end of document

Product specification

- spring clamp terminal block, THT solderable
- centerline 5.00 mm, direction of connection 90°
- fittable without loss of poles
- color black

Technical Data



General Data

Solder pin length	2.6 mm		
pole size	9		
Insulating material class	CTI 600		
clearance/creepage dist.	4 mm		
Protection category	IP20		
Min. insul. strip length	8 mm		
Rated current	19 A		
Overvoltage category	III	III	II
Pollution degree	3	2	2
Rated voltage	320 V	800 V	800 V
Rated test voltage	4 kV	4 kV	4 kV

Terminal data

rat.wiring solid AWGmax	0.2 mm ² - 2.5 mm ² / AWG 24 - AWG 14		
rat.wiring strand.AWGmax	0.2 mm ² - 2.5 mm ² / AWG 24 - AWG 12		

Approvals

 V / A / AWG	300 / 17 / 24 - 12		
approval UL - File No.	E121004		
 2.5 mm ²	250 V / 4 kV / 19 A		

Material

insulating material	PA66/PPA
flammability class	V0
spring material	Spring steel
contact material	CuSn
Contact surface	Sn
REACH	compliant
REACH - substance (SVHC)	none

Climatic Data

upper limit temperature	105 °C
lower limit temperature	-40 °C

general

Tolerance	ISO 2768 -mH
Solderability	Acc. to JEDEC JESD22-B102E 245°C/5s

Illustrations

Dimensional drawing

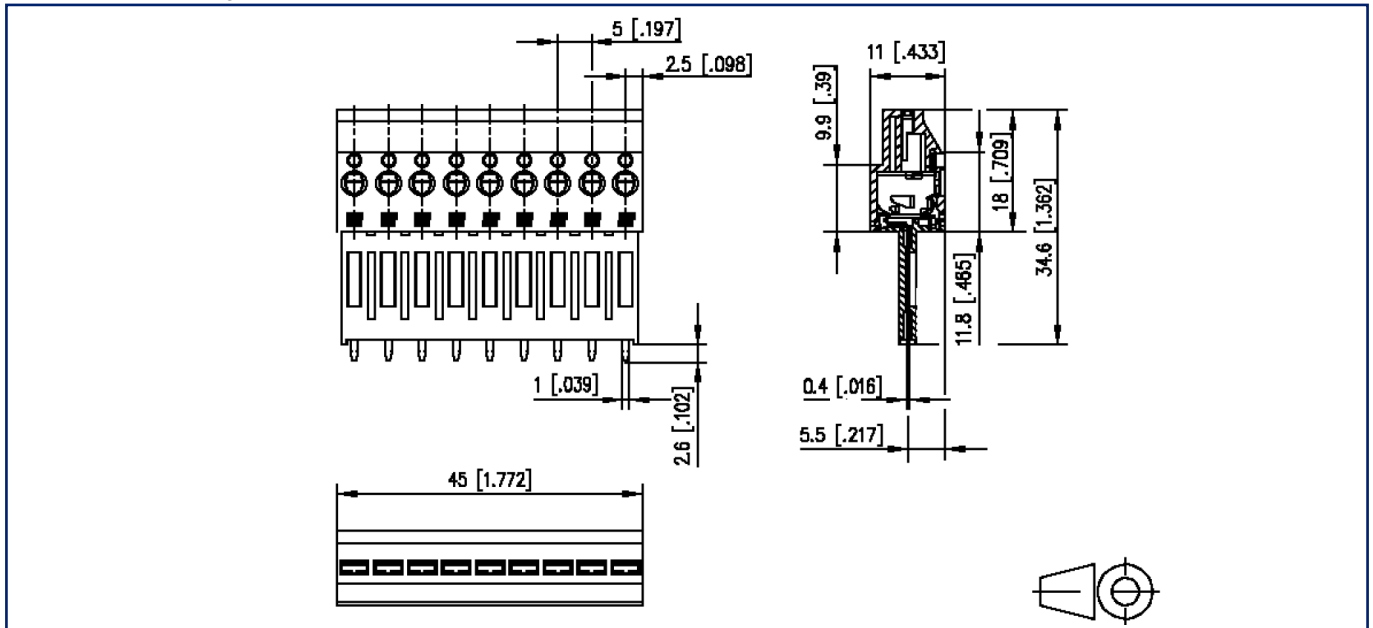

$L = (\text{pole size} - 1) \times \text{centerline} + 5 \text{ mm } [0.197]$

Illustrations

Drill pattern

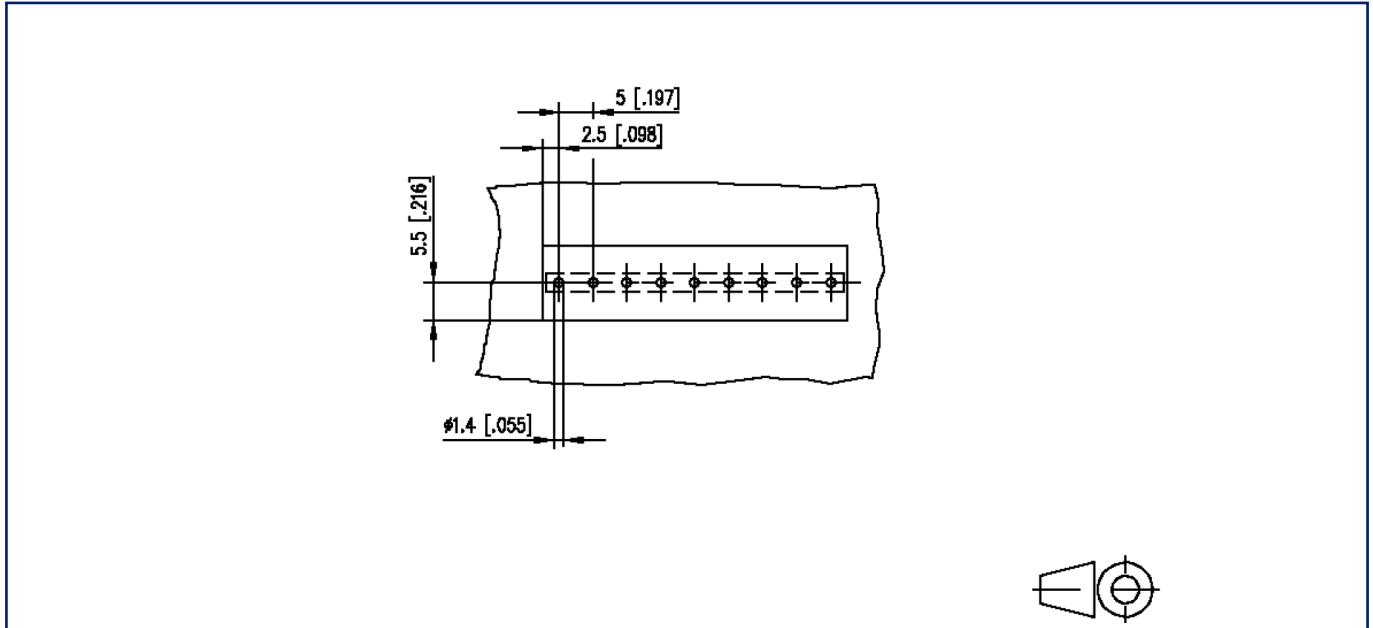

© 2022 METZ CONNECT - Technische Änderungen vorbehalten! Subject to modifications! Sous réserve de modifications techniques!