

Data sheet
RT025xxHBLC Typ 071

Illustrations

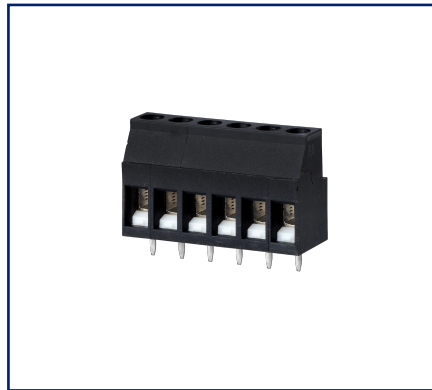

Dimensional drawing

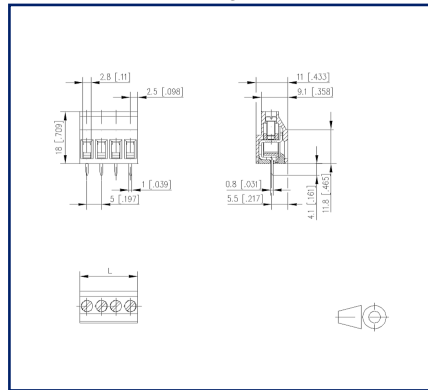

Drill pattern

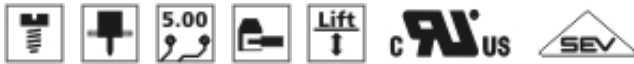
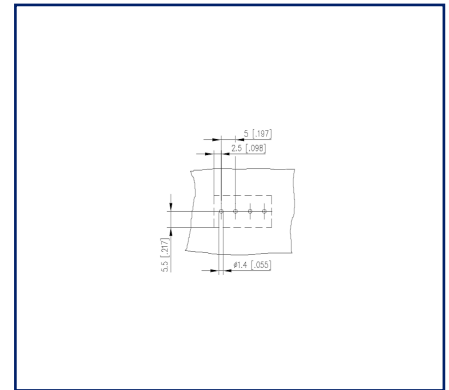

See enlarged drawings at the end of document

Product specification

- screw type terminal block, solderable
- centerline 5.00 mm, direction of connection 90°
- lift system, fittable without loss of poles
- color black

Technical Data



General Data

Tightening torque SEV	0.5 Nm		
Tightening torque UL	4.4 lb-in		
Solder pin length	4.1 mm		
min. number of poles	2		
max. number of poles	24		
Insulating material class	CTI 600		
clearance/creepage dist.	3.2 mm		
Protection category	IP20		
Min. insul. strip length	8 mm		
Rated current	16 A		
Overvoltage category	III	III	II
Pollution degree	3	2	2
Rated voltage	200 V	500 V	500 V
Rated test voltage	2.5 kV	2.5 kV	2.5 kV

Terminal data

rat.wiring solid AWGmax	0.34 mm ² - 2.5 mm ² / AWG 22 - AWG 12		
rat.wiring strand.AWGmax	0.34 mm ² - 2.5 mm ² / AWG 22 - AWG 12		

Approvals

 V / A / AWG	300 / 20 / 22 - 12		
approval UL - File No.	E121004		
 2.5 mm ²	250 V / 24 A / T60		

Material

insulating material	PA66
flammability class	V0
contact material	CuZnPb
Contact surface	Ni + Sn
terminal body thread	M3
terminal body material	CuZnPb
terminal body surface	Ni
screw thread	M3
screw material	8,8
screw surface	Zn Cr(VI)-frei/free

U | Contact

Data sheet RT025xxHBLC Typ 071

Page 3/5

P/N
310711xx

xx=number of poles

2022/04/05

Version: AA

Technical Data

Glow-Wire Flammability GWFI	960 °C acc. to IEC 60695-2-12
Glow-Wire Flammability GWIT	775 °C acc. to IEC 60695-2-13
REACH	compliant
REACH - substance (SVHC)	Lead / 7439-92-1

Climatic Data

upper limit temperature	105 °C
lower limit temperature	-40 °C

general

Tolerance	ISO 2768 -mH
Solderability	Acc. to JEDEC JESD22-B102E 245°C/5s

Illustrations

Dimensional drawing

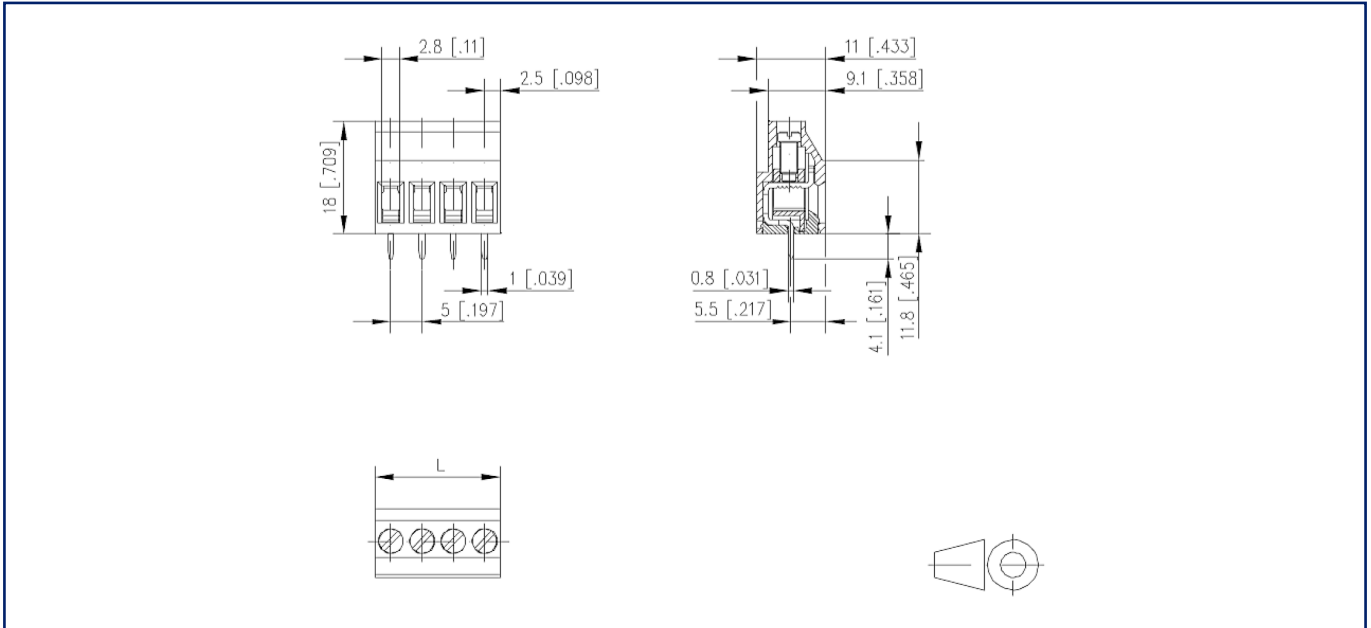

$L = (\text{pole size} - 1) \times \text{centerline} + 5 \text{ mm } [0.197]$

Illustrations

Drill pattern

