

Illustrations

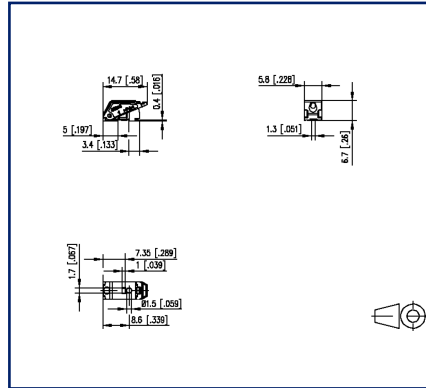

Dimensional drawing as an example



PCB-Layout

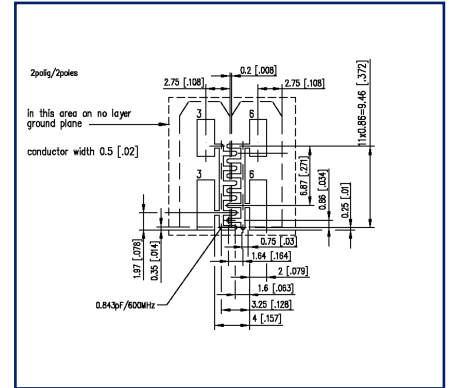

See enlarged drawings at the end of document

Product specification

- ethernet-capable spring clamp terminal block, SMT solderable
- direction of connection 90°
- fittable without loss of poles
- color orange
- Tape & Reel packaging
- finger push-button
- test point and wire connection indicator
- Variants: black, creme white, yellow, green, red, blue, orange, gray, brown, white



Technical Data



General Data

pole size	1
Insulating material class	CTI 600
Protection category	IP20
Insul. strip length	7 mm
Rated current	9 A

Terminal data

rat.wiring solid AWGmax	0.2 mm ² - 1.5 mm ² / AWG 24 - AWG 16
rat.wiring strand.AWGmax	0.2 mm ² - 1.5 mm ² / AWG 24 - AWG 16

Approvals

 V / A / AWG	300 / 9 / 24 - 16
approval UL - File No.	E121004
 0.75 mm ²	9 A / T60

Transmission characteristics

2-pole Data transmission according to IEEE 802.3cg	10 Mbit/s up to 1.000 m STP
2-pole Data transmission according to IEEE 802.3bp	1Gbit/s up to 15 m UTP 1Gbit/s up to 40 m STP
4-pole Data transmission according to IEEE 802.3i/u/y	10/100 MBit/s up to 100 m
8-pole Data transmission according to IEEE 802.3ab	1 GBit/s up to 100 m
8-pole Data transmission according to IEEE 802.3an	10 GBit/s up to 100 m
2-pole Power transmission	PoDL, IEEE 802.3bu 60 W
4-pole Power transmission	PoE, IEEE 802.3af, 15,4 W PoE+, IEEE 802.3at, 30 W
8-pole Power transmission	PoE, IEEE 802.3af, 15,4 W PoE+, IEEE 802.3at, 30 W 4PPoE, IEEE802.3bt, 90 W

Material

insulating material	PPA
flammability class	V0
spring material	Spring steel
contact material	CuSn

Technical Data

Contact surface	Sn
Glow-Wire Flammability GWFI	850 °C acc. to IEC 60695-2-12
Glow-Wire Flammability GWIT	775 °C acc. to IEC 60695-2-13

Climatic Data

upper limit temperature	105 °C
lower limit temperature	-40 °C

general

Tolerance	ISO 2768 -mH
Solderability	reflowable
Note PCB compensation	The PCB compensation is necessary to achieve the specified data transmission specifications

Application note

This product is a standard product of METZ CONNECT. METZ CONNECT is not aware of the specific intended use of the goods by the Customer or any customers of the Customer. The Customer guarantees that it has fully and sufficiently tested the use of the goods and any product modifications, product changes or product enhancements with regard to the specific intended use in accordance with the state of the art or in any other way. At METZ CONNECT's request, the Customer shall submit and make available meaningful evidence (e.g. test and laboratory protocols, certifications, etc.).



Illustrations

Dimensional drawing as an example

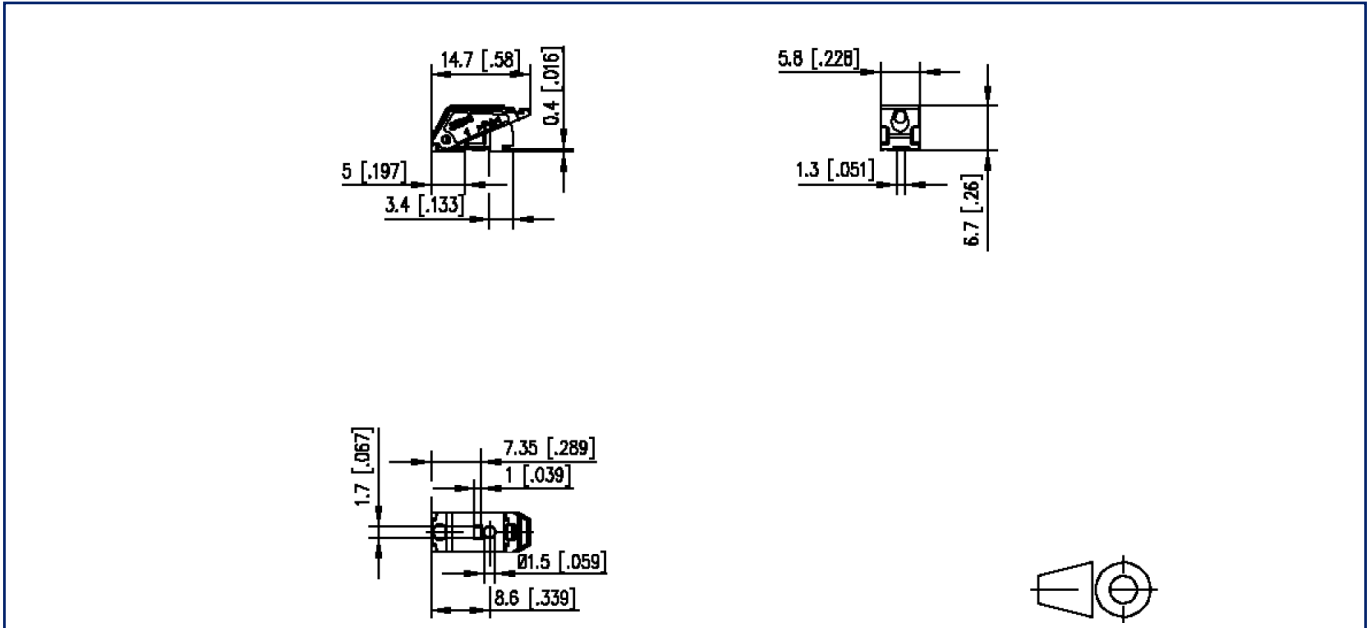

Illustrations

PCB-Layout

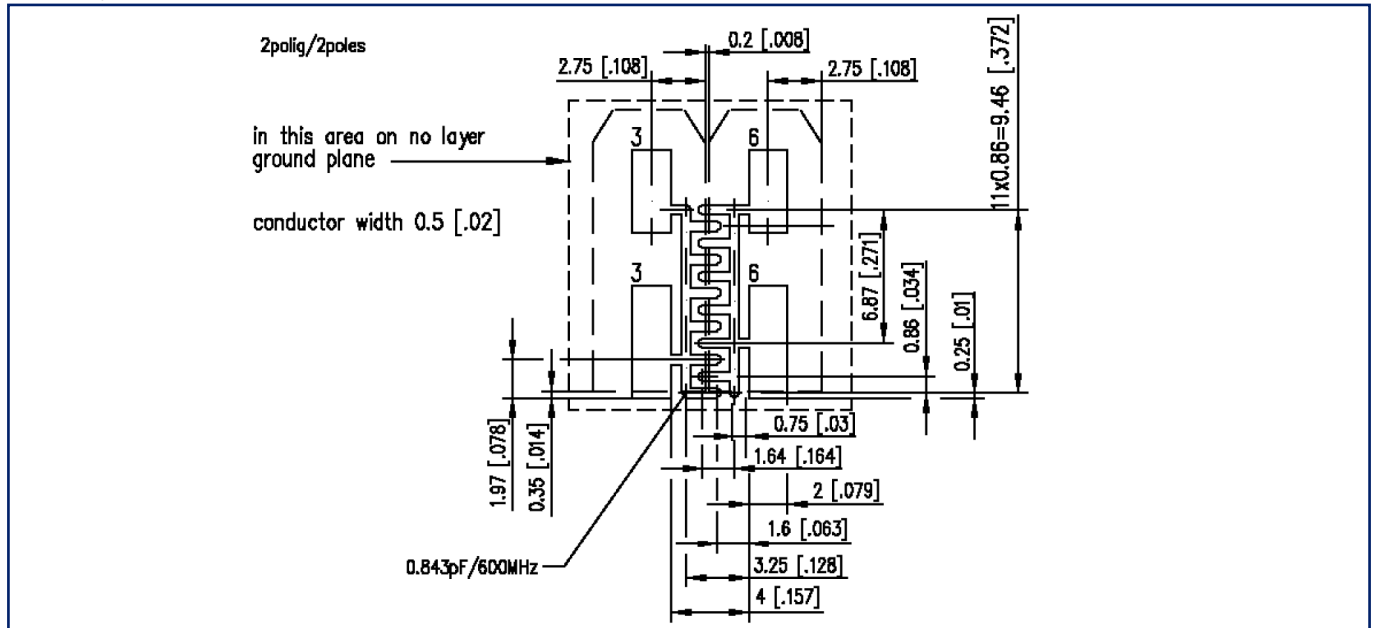

General PCB specifications

- PCB with solder resist
- PCB thickness: 1.5 mm / 2-ply
- Material: FR4
- Dielectric constant: relative permittivity = 4.4
- Copper thickness: 40 µm

Illustrations

PCB-Layout

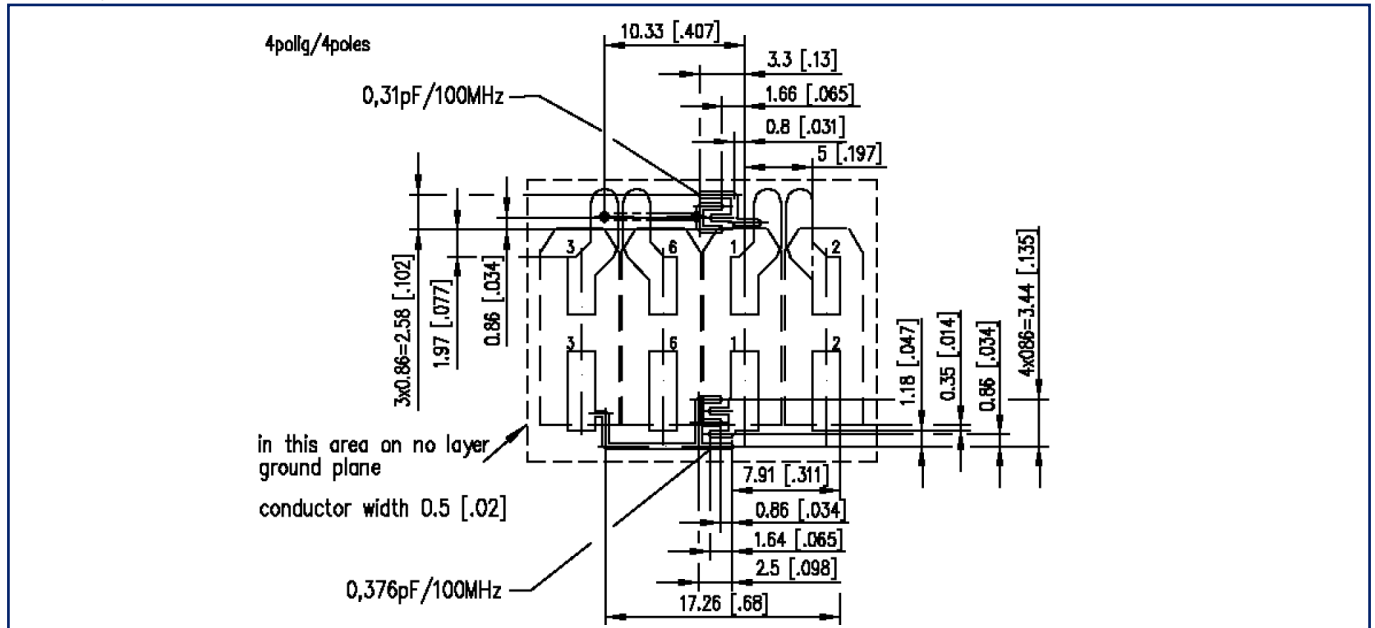

General PCB specifications

- PCB with solder resist
- PCB thickness: 1.5 mm / 2-ply
- Material: FR4
- Dielectric constant: relative permittivity = 4.4
- Copper thickness: 40 µm

Illustrations

PCB-Layout

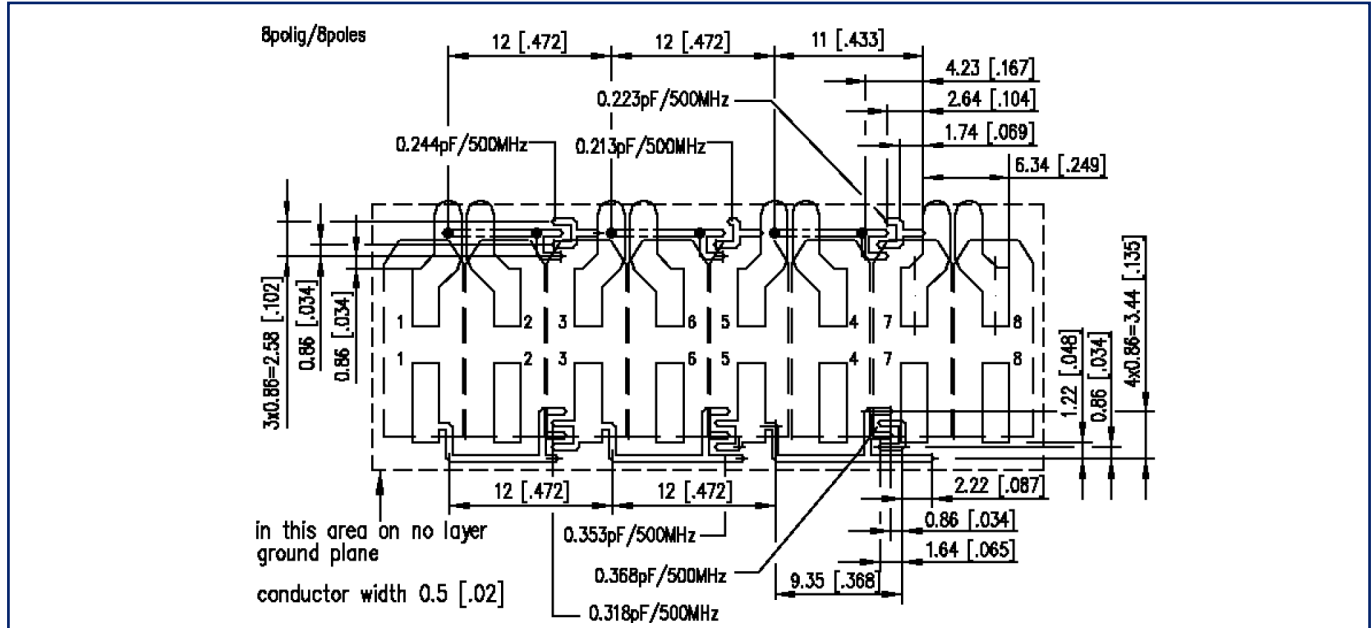

General PCB specifications

- PCB with solder resist
- PCB thickness: 1.5 mm / 2-ply
- Material: FR4
- Dielectric constant: relative permittivity = 4.4
- Copper thickness: 40 µm

Illustrations

PCB-Layout

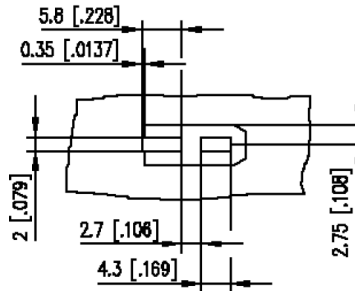

General PCB specifications

- PCB with solder resist
- PCB thickness: 1.5 mm / 2-ply
- Material: FR4
- Dielectric constant: relative permittivity = 4.4
- Copper thickness: 40 µm

