

Photomicrosensor (Reflective) EE-SY313/-SY413

⚠ Be sure to read *Precautions* on page 24.

■ Dimensions

Note: All units are in millimeters unless otherwise indicated.

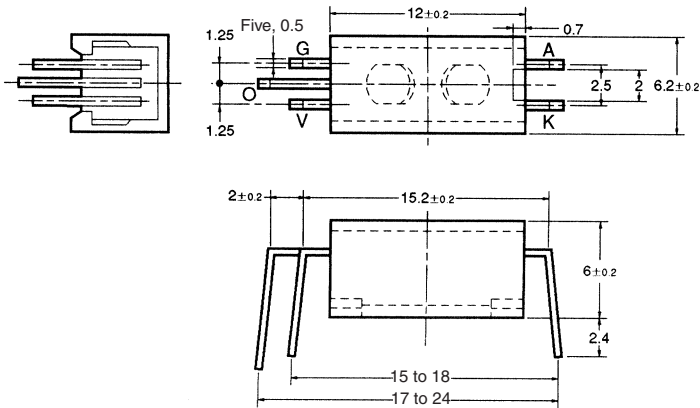

Internal Circuit

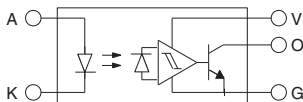

Unless otherwise specified, the tolerances are as shown below.

Terminal No.	Name
A	Anode
K	Cathode
V	Power supply (V _{CC})
O	Output (OUT)
G	Ground (GND)

Dimensions	Tolerance
3 mm max.	±0.3
3 < mm ≤ 6	±0.375
6 < mm ≤ 10	±0.45
10 < mm ≤ 18	±0.55
18 < mm ≤ 30	±0.65

■ Features

- Incorporates an IC chip with a built-in detector element and amplifier.
- Incorporates a detector element with a built-in temperature compensation circuit.
- Compact reflective Photomicrosensor (EE-SY310/-SY410) with a molded housing and a dust-tight cover.
- A wide supply voltage range: 4.5 to 16 VDC
- Directly connects with C-MOS and TTL.
- Dark ON model (EE-SY313)
- Light ON model (EE-SY413)
- Recommended sensing distance = 4.4 mm

■ Absolute Maximum Ratings (Ta = 25°C)

Item		Symbol	Rated value
Emitter	Forward current	I _F	50 mA (see note 1)
	Reverse voltage	V _R	4 V
	Pulse forward current	I _{FP}	1 A (see note 2)
Detector	Power supply voltage	V _{CC}	16 V
	Output voltage	V _{OUT}	28 V
	Output current	I _{OUT}	16 mA
	Permissible output dissipation	P _{OUT}	250 mW (see note 1)
Ambient temperature	Operating	T _{opr}	-40°C to 65°C
	Storage	T _{stg}	-40°C to 85°C
Soldering temperature		T _{sol}	260°C (see note 3)

Note: 1. Refer to the temperature rating chart if the ambient temperature exceeds 25°C.

2. The pulse width is 10 μs maximum with a frequency of 100 Hz.

3. Complete soldering within 10 seconds.

■ Electrical and Optical Characteristics (Ta = 25°C)

Item		Symbol	Value	Condition
Emitter	Forward voltage	V _F	1.2 V typ., 1.5 V max.	I _F = 20 mA
	Reverse current	I _R	0.01 μA typ., 10 μA max.	V _R = 4 V
	Peak emission wavelength	λ _p	920 nm typ.	I _F = 20 mA
Detector	Low-level output voltage	V _{OL}	0.12 V typ., 0.4 V max.	V _{CC} = 4.5 to 16 V, I _{OL} = 16 mA, without incident light (EE-SY313), with incident light (EE-SY413) (see notes 1 and 2)
	High-level output voltage	V _{OH}	15 V min.	V _{CC} = 16 V, R _L = 1 kΩ, with incident light (EE-SY313), without incident light (EE-SY413) (see notes 1 and 2)
	Current consumption	I _{CC}	3.2 mA typ., 10 mA max.	V _{CC} = 16 V
	Peak spectral sensitivity wavelength	λ _p	870 nm typ.	V _{CC} = 4.5 to 16 V
LED current when output is OFF		I _{FT}	10 mA typ., 20 mA max.	V _{CC} = 4.5 to 16 V
LED current when output is ON				
Hysteresis		ΔH	17% typ.	V _{CC} = 4.5 to 16 V
Response frequency		f	50 pps min.	V _{CC} = 4.5 to 16 V, I _F = 20 mA, I _{OL} = 16 mA
Response delay time		t _{PLH} (t _{PHL})	3 μs typ.	V _{CC} = 4.5 to 16 V, I _F = 20 mA, I _{OL} = 16 mA
Response delay time		t _{PHL} (t _{PLH})	20 μs typ.	V _{CC} = 4.5 to 16 V, I _F = 20 mA, I _{OL} = 16 mA

- Note:** 1. With incident light" denotes the condition whereby the light reflected by white paper with a reflection factor of 90% at a sensing distance of 4.4 mm is received by the photo IC when the forward current (I_F) of the LED is 20 mA.
2. Sensing object: White paper with a reflection factor of 90% at a sensing distance of 4.4 mm.
3. Hysteresis denotes the difference in forward LED current value, expressed in percentage, calculated from the respective forward LED currents when the photo IC is turned from ON to OFF and when the photo IC is turned from OFF to ON.

4. The value of the response frequency is measured by rotating the disk as shown below.

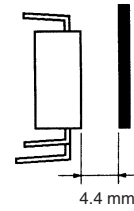
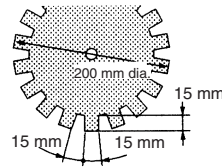

5. The following illustrations show the definition of response delay time. The value in the parentheses applies to the EE-SY413.

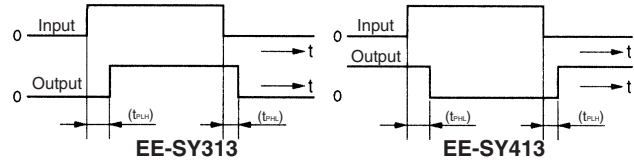

Engineering Data

Note: The values in the parentheses apply to the EE-SY413.

Forward Current vs. Collector Dissipation Temperature Rating

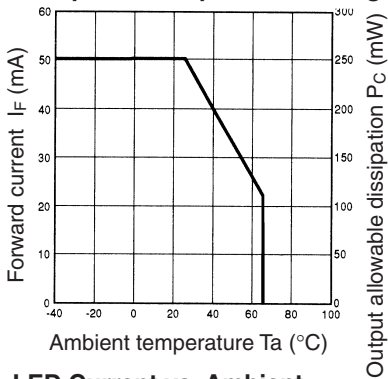

Forward Current vs. Forward Voltage Characteristics (Typical)

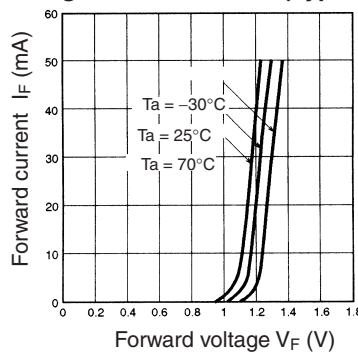

LED Current vs. Supply Voltage (Typical)

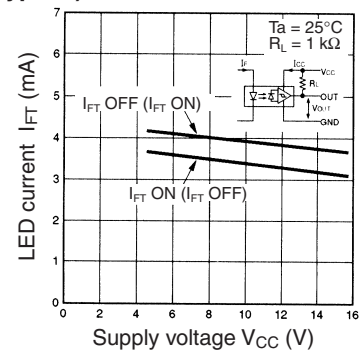

LED Current vs. Ambient Temperature Characteristics (Typical)

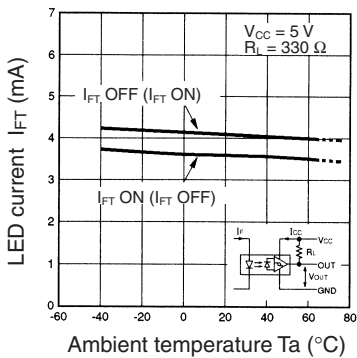

Low-level Output Voltage vs. Output Current (Typical)

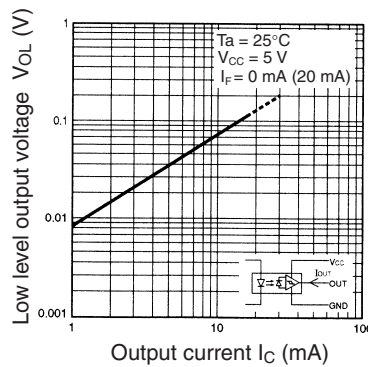

Low-level Output Voltage vs. Ambient Temperature Characteristics (Typical)

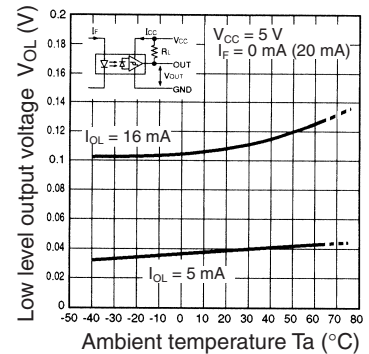

Current Consumption vs. Supply Voltage (Typical)

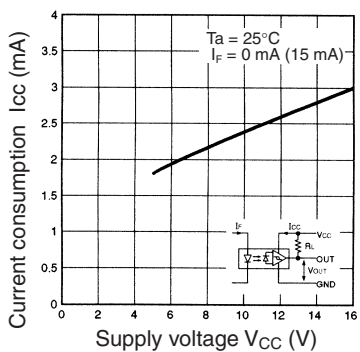

Response Delay Time vs. Forward Current (Typical)

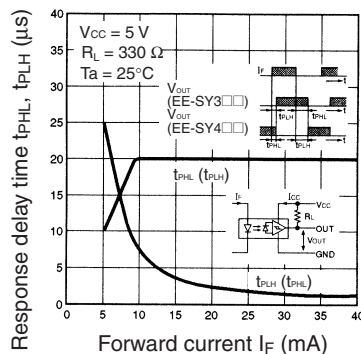

Sensing Position Characteristics (Typical)

