

## DESCRIPTION

The new NEXEM EX2/EX1 series is PC-board mount type and the most suitable for various motor and heater controls in the automobiles which require high quality and high performance.

The EX2 series is succeeding in about 60% of miniaturization in comparison with the ET2 series. The EX1 series is succeeding in about 50% of miniaturization in comparison with the ET1 series.

## FEATURES

- PC-board mounting
- Lead free solder is used
- Approx. 75% relay volume of ET2
- Approx. 60% relay space of ET2
- Approx. 88% relay weight of ET2
- Approx. 65% relay volume of ET1
- Approx. 50% relay space of ET1
- Approx. 78% relay weight of ET1

## APPLICATIONS

- Motor control
- Solenoid control



EX2 SERIES



EX1 SERIES

### For Proper Use of Miniature Relays

#### DO NOT EXCEED MAXIMUM RATING

Do not use relay under excessive conditions such as over ambient temperature, over voltage and over current. Incorrect use could result in abnormal heating and damage to the relay or other parts.

#### READ CAUTIONS IN THE SELECTION GUIDE

Read the cautions described in EM Devices' "Miniature Relays" before dose designing your relay applications.

The information in this document is subject to change without notice.

© EM Devices Corporation 2017



- All specifications in this catalog and production status of products are subject to change without notice. Prior to the purchase, please contact EM Devices for updated product data.
- Please request for a specification sheet for detailed product data prior to the purchase.
- Before using the product in this catalog, please read "Precautions" and other safety precautions listed in the printed version catalog.

SCHEMATIC (BOTTOM VIEW)

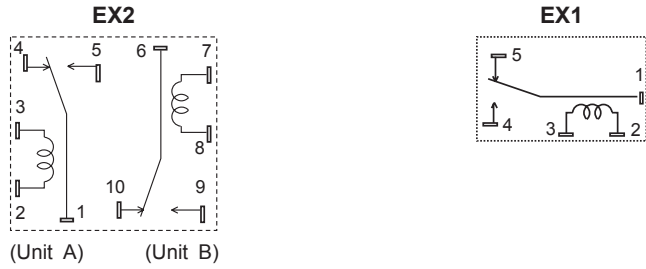

DIMENSIONS [mm]

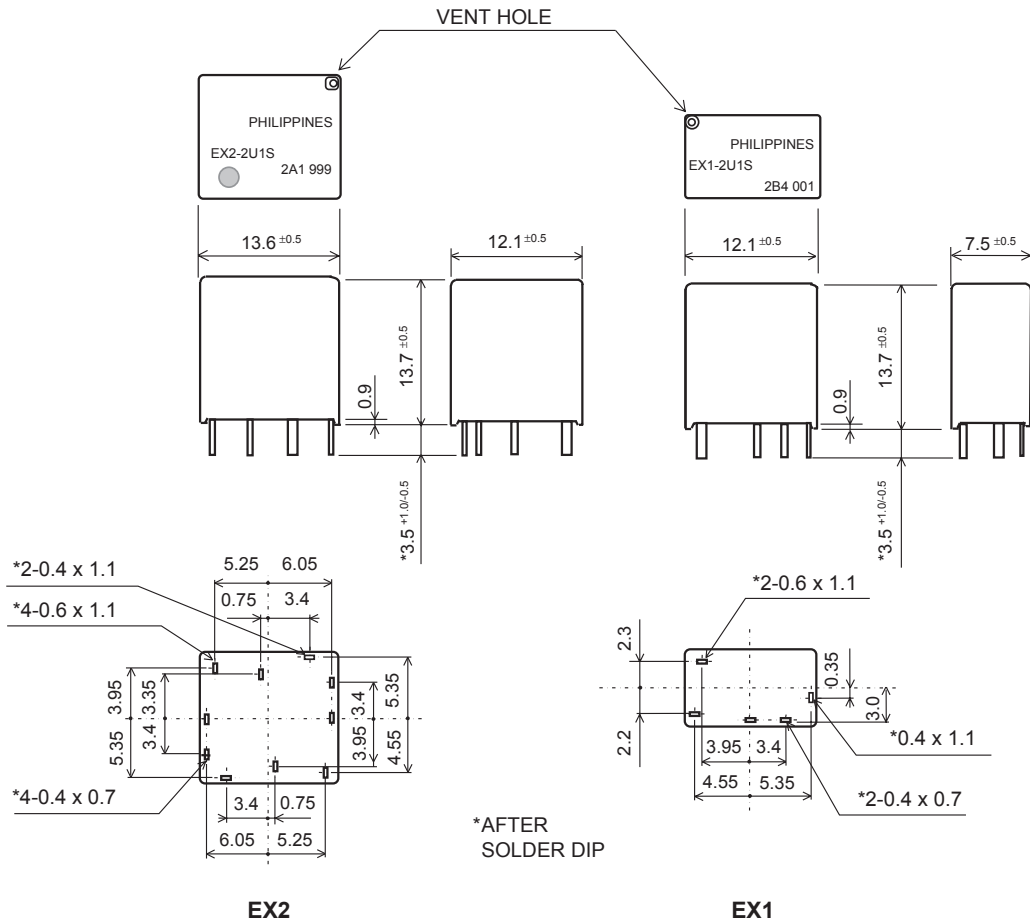

PCB PAD LAYOUT [mm] (BOTTOM VIEW)

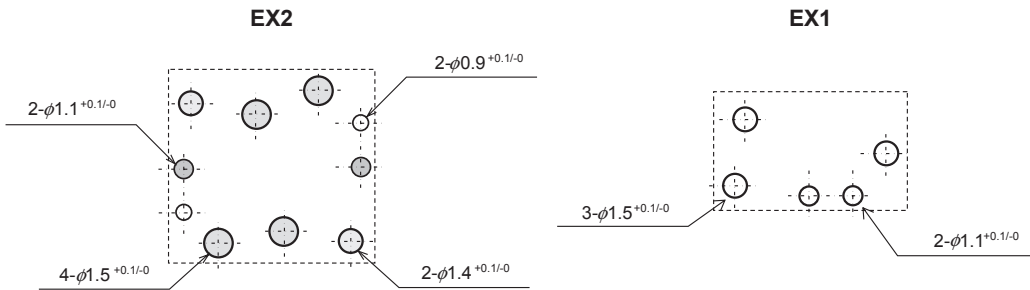

- All specifications in this catalog and production status of products are subject to change without notice. Prior to the purchase, please contact EM Devices for updated product data.
- Please request for a specification sheet for detailed product data prior to the purchase.
- Before using the product in this catalog, please read "Precautions" and other safety precautions listed in the printed version catalog.

**SPECIFICATION**

(at 20 °C)

Items		Specifications	
		EX2	EX1
Contact Form		1c x 2 (Separate)	1c
Contact Rating	Max. Switching Voltage	16Vdc	
	Max. Switching Current	30A (at16Vdc)	
	Min. Switching Current	1A (5Vdc)	
	Max. Carrying Current	35A (2minutes max. 12Vdc at 25°C) 30A (2minutes max. 12Vdc at 85°C) 20A (2minutes max. 12Vdc at 125°C)	
	Contact Resistance	4mΩ typical (measured at 7A) initial	
Contact Material		Silver oxide complex alloy	
Operate Time (Excluding Bounce)		2.5ms typical (at nominal voltage)	
Release Time (Excluding Bounce)		3ms typical (at nominal voltage with diode)	
Nominal Operate Power		900mW	
Insulation Resistance		100MΩ at 500Vdc	
Withstand Voltage	Between Open Contact	500Vac min. (for 1minute)	
	Between Contact and Coil	500Vac min. (for 1minute)	
Shock Resistance	Misoperation	98m/s <sup>2</sup>	
	Destructive Failure	980m/s <sup>2</sup>	
Vibration Resistance	Misoperation	10 to 300Hz, 43m/s <sup>2</sup>	
	Destructive Failure	10 to 500Hz 43m/s <sup>2</sup> , 200hour	
Ambient Temperature		-40 to +125 °C	
Coil Temperature Rise		70°C / W (without contact carrying current)	
Life Expectancy	Mechanical		1 x 10 <sup>6</sup> operations
	Electrical	P/W motor lock (14Vdc, 25A)	100x10 <sup>3</sup> operations
		P/W motor free (14Vdc, 25A/7A)	100x10 <sup>3</sup> operations
Weight		Approx. 6.4g	Approx. 3.5g

**COIL RATING**

(at 20 °C)

Part Numbers	Nominal Voltage (Vdc)	Coil Resistance (Ω)+/-10%	Must Operate Voltage (Vdc)	Must Release Voltage (Vdc)
EX2/1-2U1S (Sealed type)	12	160	6.5	0.9
EX2/1-2U1 (Unsealed type)	12	160	6.5	0.9



- All specifications in this catalog and production status of products are subject to change without notice. Prior to the purchase, please contact EM Devices for updated product data.
- Please request for a specification sheet for detailed product data prior to the purchase.
- Before using the product in this catalog, please read "Precautions" and other safety precautions listed in the printed version catalog.

**NUMBERING SYSTEM**

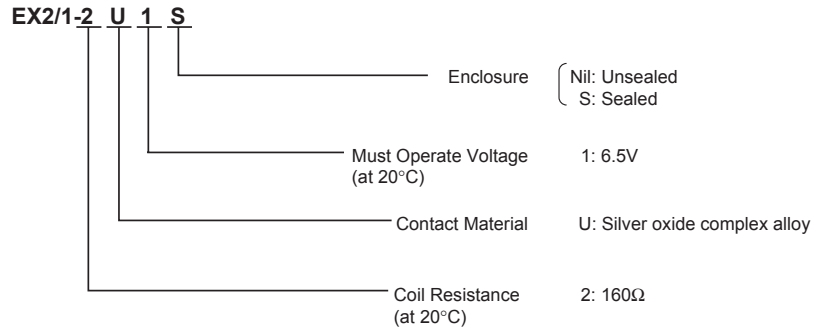

- All specifications in this catalog and production status of products are subject to change without notice. Prior to the purchase, please contact EM Devices for updated product data.
- Please request for a specification sheet for detailed product data prior to the purchase.
- Before using the product in this catalog, please read "Precautions" and other safety precautions listed in the printed version catalog.

**TECHNICAL DATA**

**Coil Temperature Rise**

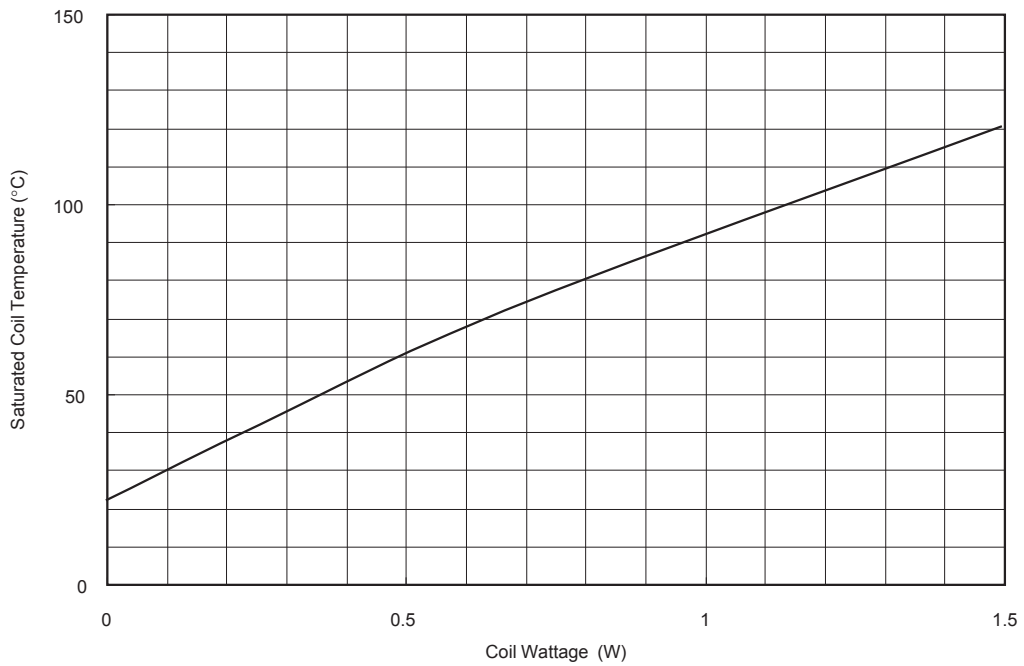
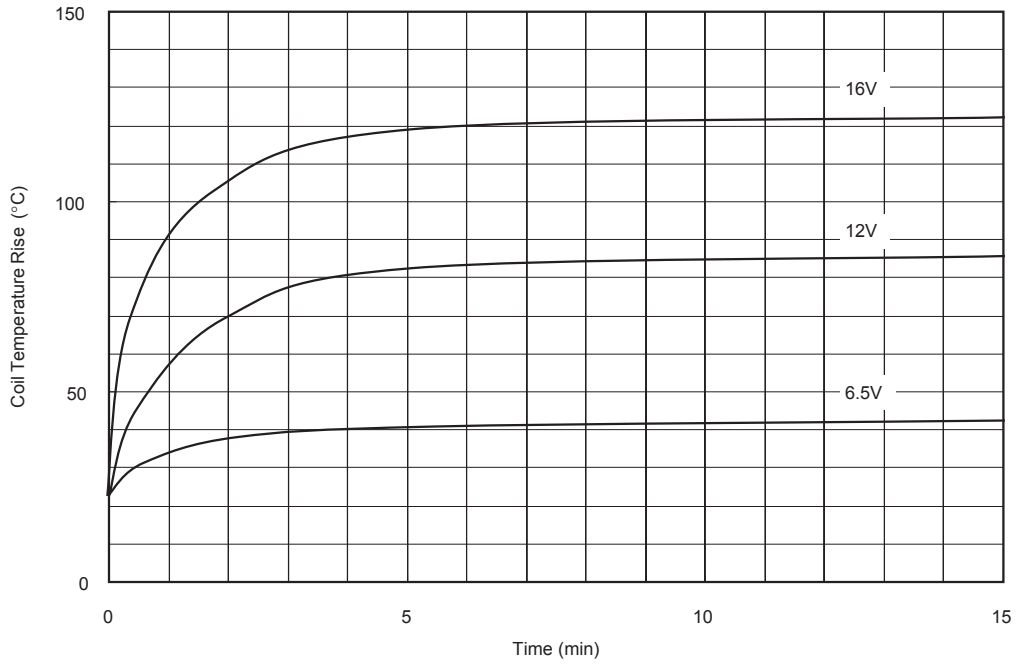

- All specifications in this catalog and production status of products are subject to change without notice. Prior to the purchase, please contact EM Devices for updated product data.
- Please request for a specification sheet for detailed product data prior to the purchase.
- Before using the product in this catalog, please read "Precautions" and other safety precautions listed in the printed version catalog.

RELAY CHARACTERISTICS DISTRIBUTION (INITIAL, n = 25 pcs., at 20°C)

Operate/Release Voltage

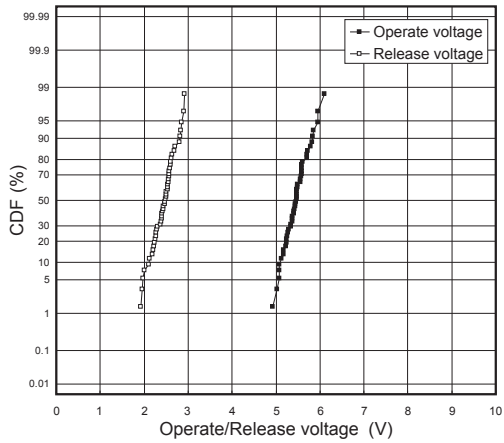

Contact Resistance

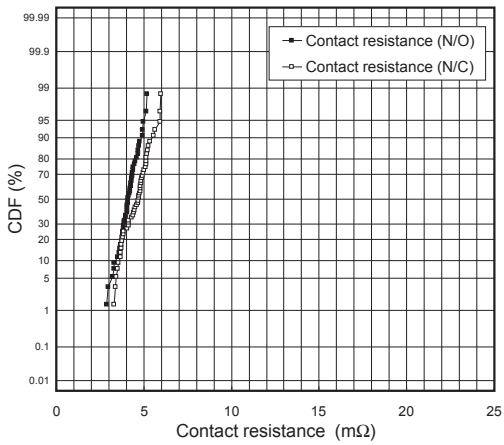

Coil Resistance

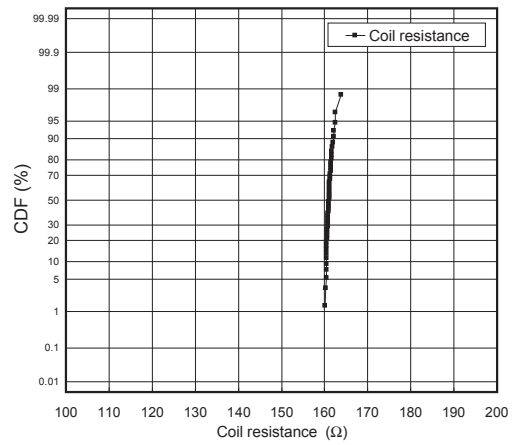

Operate Time

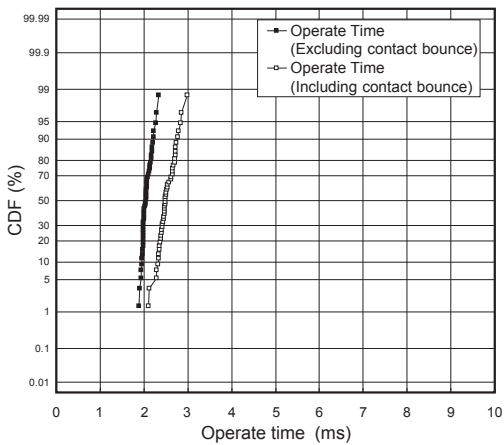

Release Time

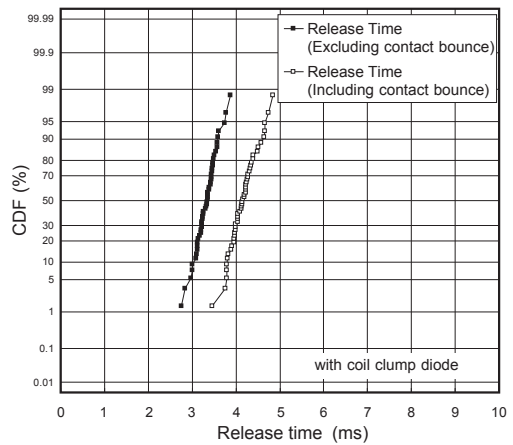

- All specifications in this catalog and production status of products are subject to change without notice. Prior to the purchase, please contact EM Devices for updated product data.
- Please request for a specification sheet for detailed product data prior to the purchase.
- Before using the product in this catalog, please read "Precautions" and other safety precautions listed in the printed version catalog.

**ELECTRICAL LIFE TEST (14Vdc-25A, P/W motor, Lock)**

Test items	Test conditions	Samples
1. Operate voltage 2. Release voltage 3. Contact resistance 4. Coil resistance 5. Operate time 6. Release time (with coil clump diode)	Temperature :20°C Frequency :0.2s ON, 9.8s OFF, 0.1Hz Contact load :14Vdc-25A, P/W motor, Lock Number of operations :100 x 10 <sup>3</sup>	EX2-2U1S 10 pcs

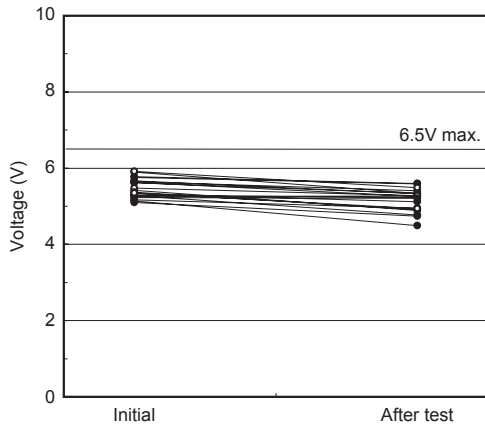

**Operate voltage**

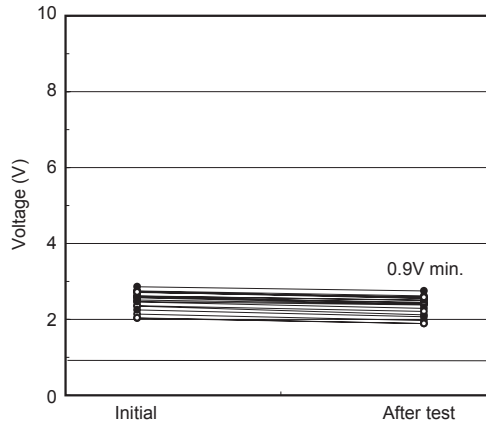

**Release voltage**

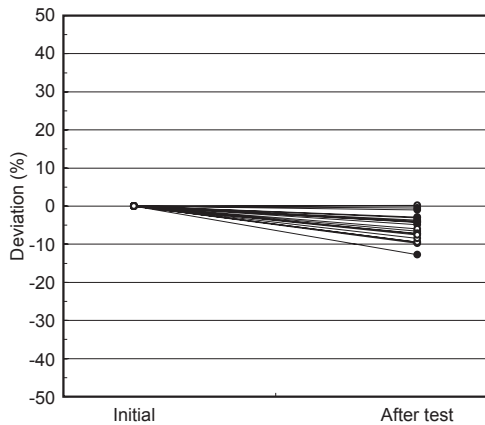

**Operate voltage**

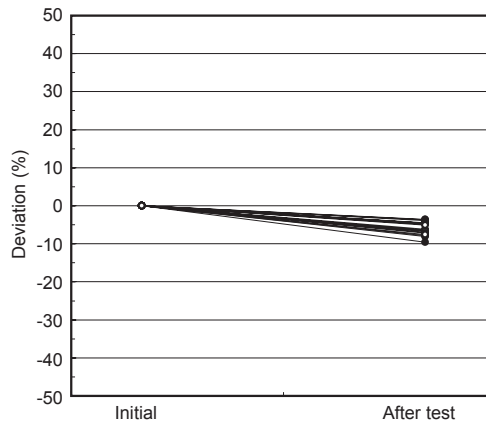

**Release voltage**



- All specifications in this catalog and production status of products are subject to change without notice. Prior to the purchase, please contact EM Devices for updated product data.
- Please request for a specification sheet for detailed product data prior to the purchase.
- Before using the product in this catalog, please read "Precautions" and other safety precautions listed in the printed version catalog.

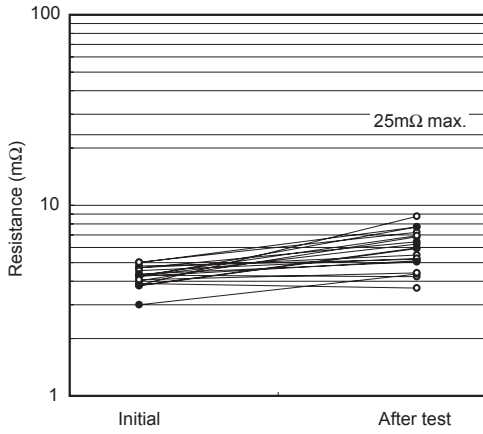

**Contact resistance (N/O)**

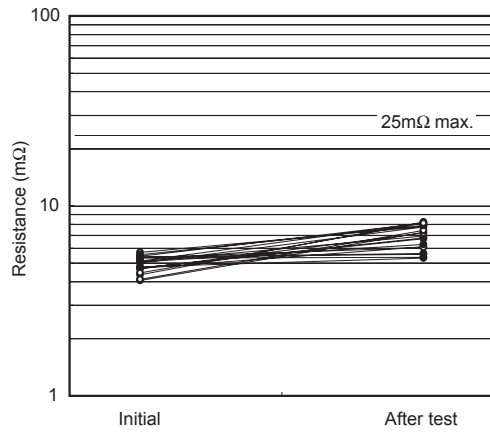

**Contact resistance (N/C)**

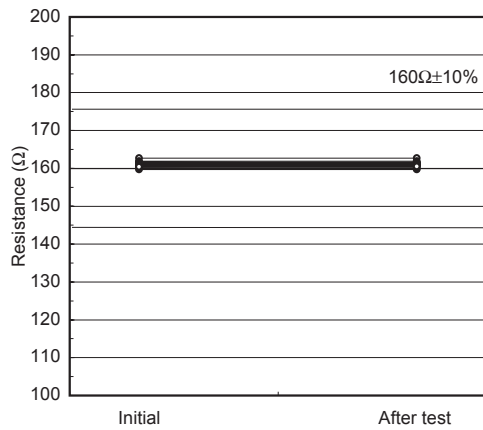

**Coil resistance**

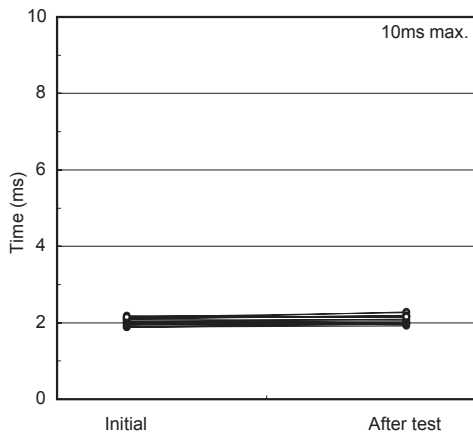

**Operate time**

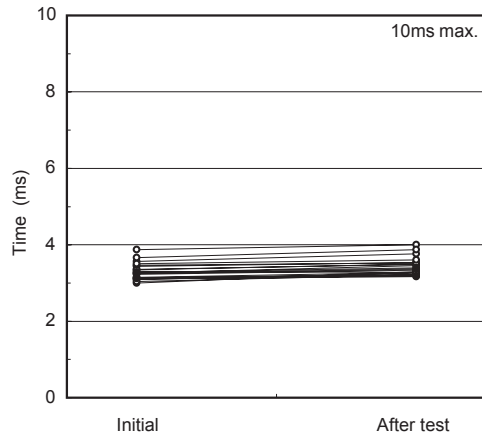

**Release time**

