

Single Pole
Standard Environment
(Super Sealed)

Limit Switches

Butt Contacts

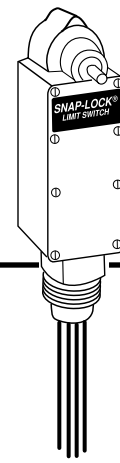

Limit Switches

- Multiple Contacts — SPDT
- Epoxy Sealed
- Generous Overtravel
- Heavy Duty Cam Operated
- Flexibility of Motion CW, CCW and CW/CCW

Wide range of operation...modular construction...practical flexibility.

The Series EA770 Super Sealed Water & Oil Tight Snap-Lock Limit Switches are the "ultimate" of the industry. By incorporating the moisture seal with these switches, trouble caused by water, soluble oils or condensation has been eliminated. The scope of models is tailored to meet today's rugged requirements...there is a model of size and type to meet virtually all demands.

Besides covering all functional requirements, this line is designed to meet practically every condition of installation. These Snap-Lock Switches provide reliable "machine-life" service and have the stamina to operate under unusual conditions...at the same time giving millions of consistently fast, accurate contacts.

Here are a few of the outstanding features built into the switch for maximum performance. Generous overtravel and by-pass, flexibility of motion, fast contact action, and Form Z contact arrangement.

Options Available

- Low temperature (-40°C to +90°C) components and lubricants.
- A variety of levers can be ordered from Namco Controls Series EL. NOTE: Levers must be ordered as separate item. See pages 294-301.
- Basic design permits mounting from either side or back. Style L or W mounting plates, for back mounting.

EA770 Single Pole 1 N.O. - 1 N.C. / Butt Contacts / Cam Action

Standard Mounting Model No.	Wide Mounting Model No.	Long Mounting Model No.	Dir. Of Operation	Angle A Trip Travel	Angle B Reset Travel	Angle C Recom. Travel	Angle D Total Travel	Angle E Min. Travel to Maintain	Angle F Overall Travel	Torque (inch lbs)	Contact Config.
STANDARD TRAVEL											
EA770-10000	EA770-40000	EA770-70000	CW	18°	14°	30°	90°	-	-	15	A
EA770-10001	EA770-40001	EA770-70001	CCW	18°	14°	30°	90°	-	-	15	B
EA770-10100	EA770-40100	EA770-70100	CW/CCW	18°	14°	30°	90°	-	-	15	C

See Operating Levers Section

Common Switch Characteristics

SINGLE POLE, STANDARD (SUPER-SEALED) ENVIRONMENT, BUTT CONTACTS	
NEMA Enclosure Type	1, 4, 6, 13
Housing Material	Zinc
Ambient Temperature Range*	-20°C to +90°C
Shipping Weight	3 lbs. approx.
Lever Adjustment	7°30' Increments Thru 360°
Contacts	Butt, Silver Alloy, Form Z
Lead Wires**	4 lead wires, part no. shown is for 15 ft.

*Some low temperature (-40°C to +90°C) versions available. Contact factory.
 **Available in increments of 5 ft. Contact factory.

Continuous Current Rating - Amperes

VOLTAGE	AC	DC
125	20.0	5.0
250	15.0	1.5
480	10.0	-
600	5.0	-

75-100% Power Factor

Contact Configurations

CIRCUIT A

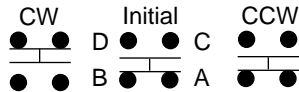

CIRCUIT B

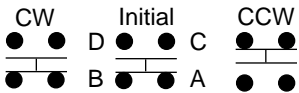

CIRCUIT C

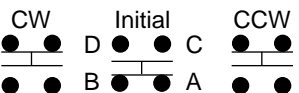

Operational Data Drawings

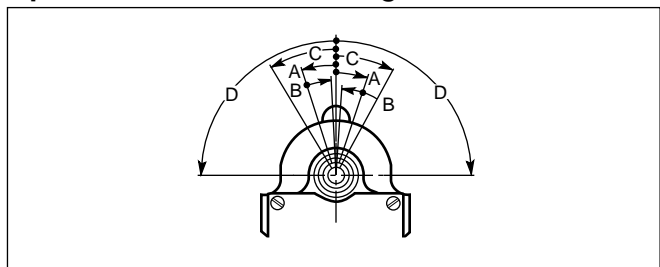

Dimensions and Mounting

EA770

STANDARD MOUNTING PLATE

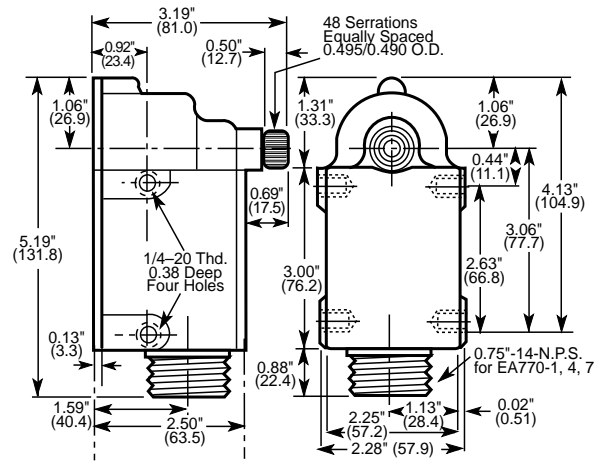

WIDE MOUNTING PLATE

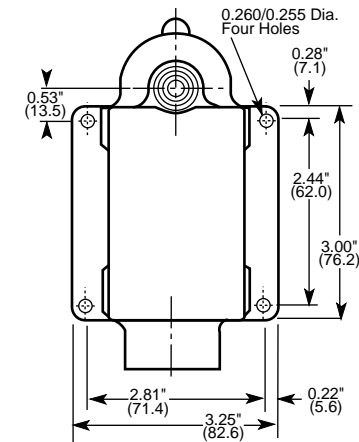

LONG MOUNTING PLATE

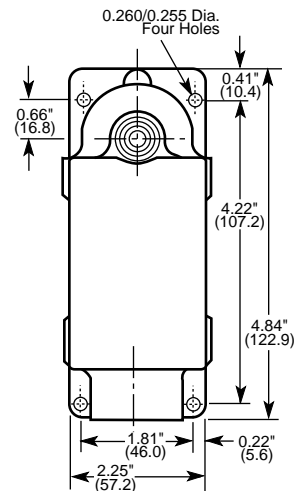

Limit Switches

NAMCO

Namco Controls Corporation
 Mayfield Village, OH 44143
 (440) 460-1360 • FAX (440) 460-3800 • namcocontrols.com

For technical assistance, call 1-800-NAMTECH