

Description

Magnecraft™ General Purpose Relays

750H Hazardous Location Series

DPDT, 3PDT 12 A



UL listed when used with proper Magnecraft™ sockets



750H Hazardous Location Relay

Description

The hermetically sealed 750H Series relays comply with UL Class I Division 2 requirements for use in hazardous locations.

Feature	Benefit
Hermetically sealed	Complies with UL Class I Division 2 for Hazardous Locations Groups A, B, C, & D; sealed for wash down conditions
Octal style mounting	Robust & historically-proven mounting platform that provides excellent structural support
12 A max. switching current	Ideal for automation & control applications
DPDT & 3PDT contact configuration	Simultaneously control separate circuits
Socket mount option	Simplifies installation & maintenance while also allowing the use of protection modules, hold-down clips & other accessories

Contact Rating	Contact Configuration	Nominal Voltage	Coil Resistance (Ω)	Standard Part Number
12 A	DPDT	24 Vac 50/60 Hz	72	750XBXH-24A
		120 Vac 50/60 Hz	1700	750XBXH-120A
		12 Vdc	120	750XBXH-12D
		24 Vdc	470	750XBXH-24D
		110/125 Vdc	10000	750XBXH-110/125D
	3PDT	24 Vac 50/60 Hz	72	750XCXH-24A
		120 Vac 50/60 Hz	1700	750XCXH-120A
		24 Vdc	470	750XCXH-24D
		110/125 Vdc	10000	750XCXH-110/125D

Part Number Explanation

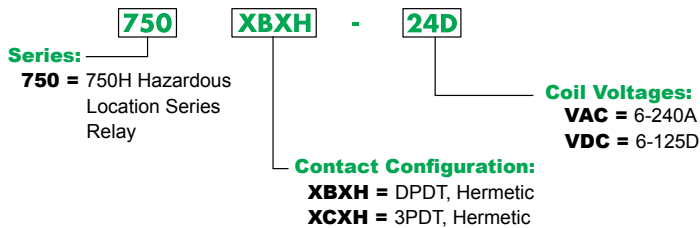

*Please note that 1A Bifurcated and 3A Silver Alloy versions are also available.
Please contact Customer Service for more information (847-441-2540).

Magnecraft™ General Purpose Relays

750H Hazardous Location Series

DPDT, 3PDT 12 A

Specifications (UL 508)

Part Number	750XBXH	750XCXH
Contact Characteristics		
Terminal Style	Octal	Octal
Contact Configuration	DPDT	3PDT
Maximum Current	12 A	12 A
Load Type	Standard	Standard
Contact Materials	Silver Alloy	Silver Alloy
Maximum Switching Voltage	300 V	300 V
Rated Switching Current at Voltage	Resistive: 12 A at 120 Vac 50/60 Hz; 12 A at 240 Vac 50/60 Hz; 12 A at 28 Vdc Motor: 1/2 hp at 240 Vac 50/60 Hz; 1/3 hp at 120 Vac 50/60 Hz Pilot Duty: B300	Resistive: 12 A at 120 Vac 50/60 Hz; 12 A at 240 Vac 50/60 Hz; 12 A at 28 Vdc Motor: 1/2 hp at 240 Vac 50/60 Hz; 1/3 hp at 120 Vac 50/60 Hz Pilot Duty: B300
Minimum Switching Requirement	100 mA at 5 Vdc (0.5 W)	100 mA at 5 Vdc (0.5 W)
Coil Characteristics		
Maximum Operating Voltage	110% (AC / DC)	110% (AC / DC)
Maximum Pickup Voltage	85% (AC); 80% (DC)	85% (AC); 80% (DC)
Drop-out Voltage Threshold	15% (AC); 10% (DC)	15% (AC); 10% (DC)
Average Consumption	1.2 VA (AC); 0.9 W (DC)	2 VA (AC); 1.2 W (DC)
General Characteristics		
Electrical Life at Rated Load	100,000 operations	100,000 operations
Mechanical Life (Unpowered)	10,000,000 operations	10,000,000 operations
Operating Time (Response Time)	20 ms	20 ms
Dielectric Strength - Between Coil and Contact (AC)	1500 V(rms)	1500 V(rms)
Dielectric Strength - Between Poles (AC)	1500 V(rms)	1500 V(rms)
Ambient Air Temperature around the Device - Storage	-40 – +85 °C (-40 – 185 °F)	-40 – +85 °C (-40 – 185 °F)
Ambient Air Temperature around the Device - Operation	-40 – +55 °C (-40 – 131 °F)	-40 – +55 °C (-40 – 131 °F)
Vibration Resistance - Operational	3 g-n at 10-55 Hz	3 g-n at 10-55 Hz
Shock Resistance	10 g-n	10 g-n
Degree of Protection	IP 67	IP 67
Weight	130 g (4.59 oz)	130 g (4.59 oz)
Agency Approvals	UL with socket, UR (E209950), RoHS	UL with socket, UR (E209950), RoHS

Note: Actual product performance may vary depending on application and environmental conditions.

Dimensions — inches (millimeters)

750H

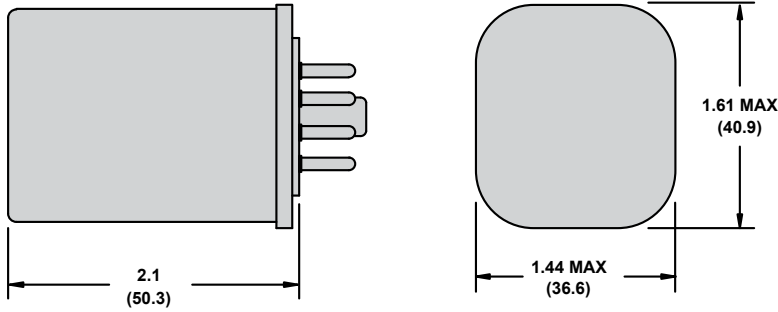

Wiring Diagrams

DPDT

3PDT

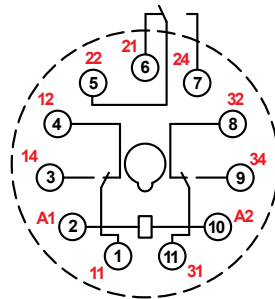
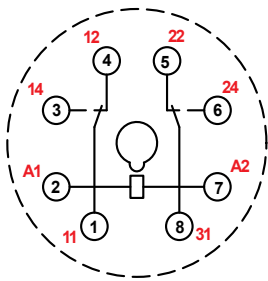

NEMA
IEC

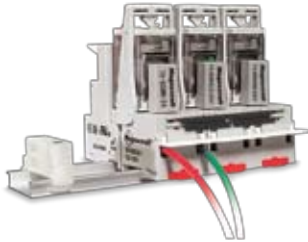

Description

Optional sockets offer customizable, finger-safe™ solutions including protection modules, hold-down clips, and ID tags. Sockets are DIN rail and panel mount compatible.

Relay Accessories

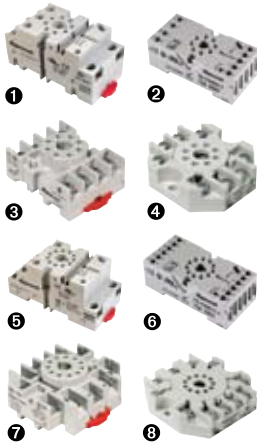

Description	Function	For Use With Relays	Pkg. Min.	Standard Part Number
Socket 1	DIN/Panel Mount with Screw Terminals	750XBXH	10	70-750DL8-1
Socket 2	DIN/Panel mount with elevator terminals, module compatible	750XBXH	10	70-750E8-1
Socket 3	DIN/Panel mount with screw terminals & clamping plates	750XBXH	10	70-464-1
Socket 4	Panel mount with screw terminals & clamping plates	750XBXH	10	70-169-1
Socket 5	DIN/Panel Mount	750XCXH	10	70-750DL11-1
Socket 6	DIN/Panel mount with elevator terminals	750XCXH	10	70-750E11-1
Socket 7	DIN/Panel mount with screw terminals & clamping plates	750XCXH	10	70-465-1
Socket 8	Panel mount with screw terminals & clamping plates	750XCXH	10	70-170-1

Socket Accessories

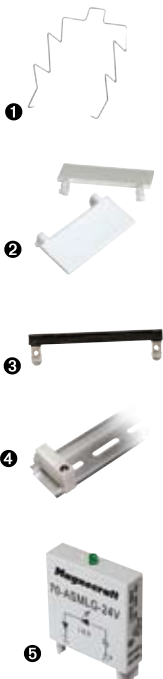

Description	Function	For Use With Sockets	Coil Voltage	Pkg. Min.	Standard Part Number
Metal Spring Clip 1	Secures relay in socket	70-750DL8-1, 70-750E8-1, 70-464-1, 70-750E11-1, 70-750DL11-1, 70-465-1	–	10	16-1351
Plastic I.D. Tag 2	Write-on plastic labels	70-750E8-1, 70-750E11-1	–	10	16-750/788FT-1
Insulated Coil Bus Jumper System 3	Wireless Socket Connection	70-750DL8-1, 70-750DL11-1	–	10	16-750/788CBJ-1
Extruded Aluminum DIN Rail, 39.37" (1000 mm) 4	Quick installation and removal of sockets	70-750DL8-1, 70-750E8-1, 70-464-1, 70-750E11-1, 70-750DL11-1, 70-465-1	–	10	16-700DIN
DIN Rail End Clip 4	Holds sockets firmly in place on DIN rail	–	–	10	16-DCLIP-1
Large Socket Module	MOV Suppressor <i>(Protects from damaging electrical spikes)</i>	70-750DL8-1, 70-750E8-1, 70-750E11-1, 70-750DL11-1	24 Vac/Vdc	10	70-ASMM-24
Large Socket Module	Protection Diode <i>(Protects external drive circuitry from inductive voltages)</i>		120 Vac/Vdc	10	70-ASMD-250
Large Socket Module 5	LED Indicator <i>(Provides coil status at a glance)</i>		110/240 Vac/Vdc	10	70-ASMLG-110/240
Large Socket Module	RC Suppressor <i>(Snubs back EMF of relay coil)</i>		110/240 Vac/Vdc	10	70-ASMR-110/240

Note: Use of LED or RC socket module may increase coil power draw by up to 10%.