

PRINTED CIRCUIT MOUNT SOCKET SELECTION GUIDE



PRODUCT

70-781T-1



70-402-1 & 70-379-1



MANUFACTURED UNDER ISO 9001

70-178-1 & 70-178-2



MANUFACTURED UNDER ISO 9001

70-304-1  
70-306-1  
70-308-1  
70-310-1



L X W X H (INCHES)

1.22 x 0.709 x 0.739

SEE PAGE 35

SEE PAGE 36

SEE PAGE 37

FEATURES

✦ PC STYLE  
5 PIN BASE  
✦ DESIGNED FOR PC BOARD MOUNT APPLICATIONS

✦ PC STYLE  
8 OR 14 PIN BASE  
✦ DESIGNED FOR PC BOARD MOUNT APPLICATIONS

✦ PC STYLE  
11 PIN BASE  
✦ DESIGNED FOR PC BOARD MOUNT APPLICATIONS

✦ PC STYLE  
8 TO 26 PIN BASE  
✦ DESIGNED FOR PC BOARD MOUNT APPLICATIONS

FINGER SAFE PER IP 20

-

-

-

-

WIRING TERMINATIONS

0.080 x 0.010  
PC TERMINALS

0.080 X 0.010 ( 8 PIN ) PC  
OR 0.060 X 0.010  
( 14 PIN ) PC TERMINALS

0.060 X 0.030  
PC TERMINALS

0.070 X 0.030  
PC TERMINALS

CONSTRUCTION

UNITS

Width:	mm
Module Compatible:	No
1 Piece Solderless Track And Terminals System:	Yes
Logic Style: I-O Separation:	No
Coil Jumper Buss System Available:	No

18

21.6

38.1

19.5

No

No

No

No

Yes

Yes

Yes

Yes

No

No

No

No

No

No

No

No

ELECTRICAL RATING

Nominal Voltage Rating:	Volts
Nominal Current Rating:	Amps

300

300

300

300

15

10

15

10

DIELECTRIC STRENGTH

Output to Adjacent Terminals:	V rms
Output to Input Terminals:	V rms
Terminals to Rail Chassis	V rms

2500

2000

2000

2500

2500

1000

1000

TEMPERATURE

Operating, Lower:	°C
Operating, Lower:	°C

-40

-40

-40

-40

+80

+80

+80

+80

MISCELLANEOUS

Protection Category (finger safe):	IP
Weight:	grams

N / A

N / A

N / A

N / A

51

3.1 to 6.2

102 or 129

4.3 to 9.6

AGENCY APPROVALS

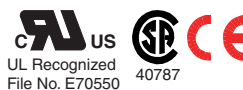

PAGE NUMBER

PAGE 34

PAGE 35

PAGE 36

PAGE 37



COMPLIES WITH REQUIREMENTS OF

- \* IEC STANDARDS 947-4-1 AND 947-5-1 LOW VOLTAGE DIRECTIVE
- \* IEC = INTERNATIONAL ELECTROTECHNICAL COMMISSION
- \* CE TESTING AND EVALUATION PERFORMED BY THE UNDERWRITERS LABORATORIES AS A THIRD PARTY PARTICIPANT

### RECOMMENDED PRINTED CIRCUIT LAYOUT TOP VIEW

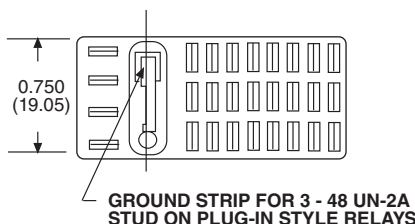
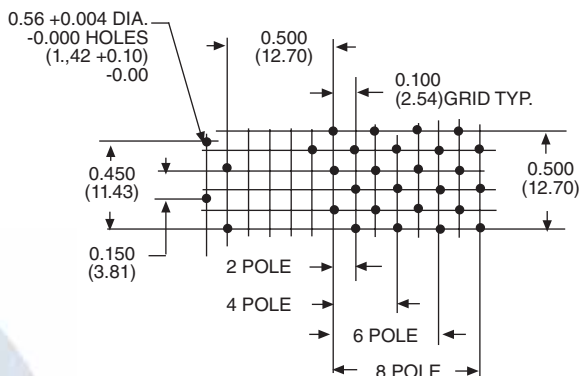

**NOTE:**  
WHEN INSTALLING SOCKET(S) INTO A PRINTED CIRCUIT BOARD, USE PLUG-IN STYLE RELAYS FOR MAXIMUM TERMINAL CONTACT WITH MATING SOCKET. PLUG-IN STYLE RELAYS HAVE A GROUNDING STUD AND ARE RECOMMENDED FOR USE WITH ALL SOCKET STYLES.

### OUTLINE DIMENSIONS

DIMENSIONS SHOWN IN INCHES & (MILLIMETERS).  
TOLERANCES: ± 0.010 (± 0.25)  
UNLESS OTHERWISE SHOWN

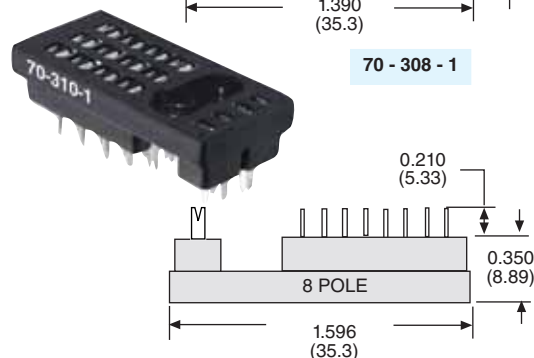
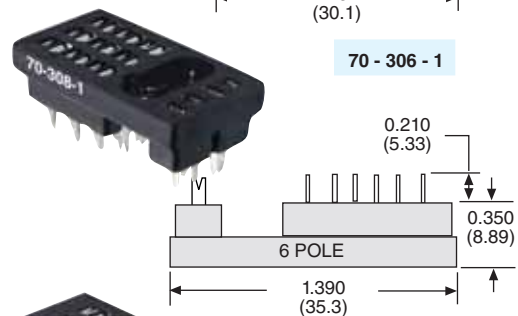
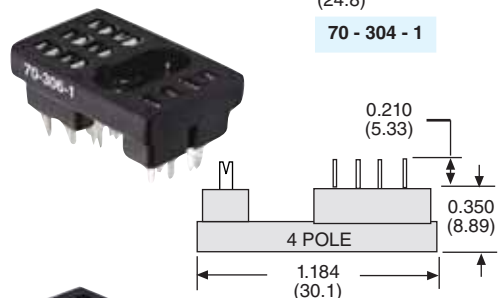
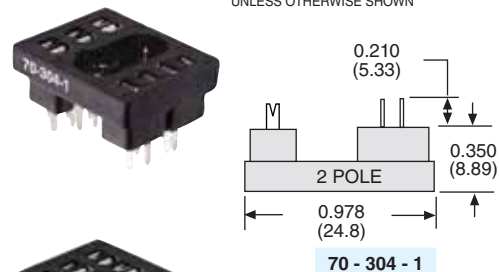

HOLD DOWN CLIPS ARE INCLUDED

**Mating Relay**  
**67**

See section 1

Mating Hold Down Clips

(70-304-1) 16-875-1

(70-306-1) 16-875-2

(70-308-1) 16-875-3

(70-310-1) 16-1120-8

## GENERAL SPECIFICATIONS (@ 25°C)

	UNITS	
<b>NUMBER OF TERMINALS</b>		8, 14 or 20
<b>ELECTRICAL RATING</b>		
Nominal Voltage Rating:	Volts	300
Nominal Current Rating:	Amps	10
<b>DIELECTRIC STRENGTH</b>		
Output to Adjacent output Terminals:	V rms	1000
Output to Input Terminals:	V rms	1000
Terminals to Rail Chassis:	V rms	1000
<b>CONSTRUCTION</b>		
Protection Category (Finger Safe):	IEC	N / A
Internal Metal Tracks:		Copper Alloy, Zinc Plated
<b>TEMPERATURE</b>		
Operating, Lower:	°C	-40
Operating, Upper:	°C	+80
<b>MISCELLANEOUS</b>		
Chassis Mount Screw Torque:	Lb-in / Nm	N / A
Flammability Rating:		
Wire Size:	AWG/mm2	N / A
Body Color:		Black
Weight:	grams	4.3 - 6.9

STANDARD PART NUMBER	DESCRIPTION
70 - 304 - 1	2 POLE PRINTED CIRCUIT TERMINALS
70 - 306 - 1	4 POLE PRINTED CIRCUIT TERMINALS
70 - 308 - 1	6 POLE PRINTED CIRCUIT TERMINALS
70 - 310 - 1	8 POLE PRINTED CIRCUIT TERMINALS