

Electromechanical Printed Circuit Board Relays – Application Data

Introduction:

In the past several years the dry reed relay has become an important product among relay specifiers, primarily because of the tremendous increases in low level switching for computers, business machines, and communication appliances. The dry reed relay has the great advantage of being hermetically sealed and is thus impervious to atmospheric contamination. It is very fast and, when operated within the rated contact loads, it offer a reliable switching component and extremely long life.

How Reed Relays Work:

The basic element of the reed relay is the glass reed capsule commonly known as a reed switch. A reed switch consists of two overlapping, flat, ferromagnetic reeds, separated by a small air gap, sealed in a glass capsule. The reeds are supported at the point where they are sealed into the ends of a glass tube and therefore act as cantilevers. If the free ends of the reeds are placed in a magnetic field, the flux in the gap between the reeds will cause them to pull together. When the magnetic field is removed, the reeds will spring apart due to the spring tension in the reeds. The reeds thus provide a magnetic operating gap and serve as a contact pair to close and open an electrical circuit.

A typical dry reed switch capsule is shown in Figure 1.

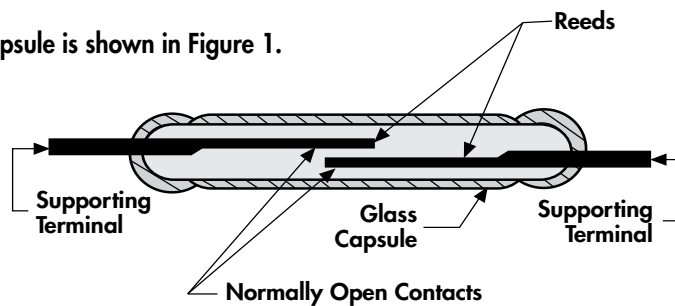

Figure 1

In the basic SPST-NO design, two opposing reeds are sealed into a narrow glass capsule and overlapped at their free ends. The contact area is plated typically with rhodium to produce a low contact resistance when contacts are drawn together. The capsule is made of glass and filled with a dry inert gas and then sealed. The capsule is surrounded by an electromagnetic coil. When the coil is energized, the normally open contacts are brought together; when the coil voltage is removed, the reeds separate by their own spring tension. Some reeds contain permanent magnets for magnetic biasing to achieve normally closed contacts (SPST-NC) or SPDT contact combinations. The current rating, which is dependent upon the size of the reed and the type and amount of plating, may range from low level to 1 amp. Effective contact protection is essential when switching loads other than dry resistive loads.

Advantages:

- Sensitive in operation, which enables the reed relay to be driven by low cost IC's.
- Small Physical Size
- High Insulation Resistance
- High Reliability
- Long Life
- Low Cost
- Fast Switching Capability

Contact Combinations:

The switches used in dry reed relays provide SPST- NO, SPST-NC, SPDT contact combinations. The SPST-NO corresponds with the basic switch capsule design (Figure 1). The SPST-NC results from a combination of the SPST-NO switch and a permanent magnet strong enough to pull the contacts closed but able to open when coil voltage is applied to the relay coil. In typical true SPDT designs, the armature is mechanically tensioned against the normally closed contact, and is moved to the normally open contact upon application of a magnetic field.

Magnetic Fields:

Reed relays in general can be characterized as susceptible to the influences of external magnetic fields. It is important to keep reed relays at a proper distance from each other because of the possibility of magnetic-interaction between them. Proper magnetic shielding must be used to contain stray magnetic fields. When installing reed relays into equipment, one should be aware of the devices within that equipment which can produce magnetic fields. The relays being installed into that equipment should be positioned as far away as possible from any stray magnetic fields and should be shielded to prevent false operations. A general rule is to space reed relays no closer together than 0.5 inches.

Electrical Characteristics:

Sensitivity: The input power required to operate dry reed relays is determined by the sensitivity of the particular reed switch used, by the number of switches operated by the coil, by the permanent magnet biasing (if used), and the efficiency of the coil and the effectiveness of its coupling to the blades. Minimum input required to affect closure ranges from the very low milliwatt level for a single sensitive capsule to several watts for multi-pole relays.

Operate Time: The coil time constant, overdrive on the coil, and the characteristics of the reed switch determine operate time. With the maximum overdrive voltage applied to the coil, reed relays will operate in approximately the 200 microsecond range. When driven at rated coil voltage, usually the relays will operate at about one millisecond.

Release Time: With the coil unsuppressed, dry reed switch contacts release in a fraction of a millisecond. SPST-NO contacts will open in as little as 50 microseconds. Magnetically biased SPST-NC and SPDT switches re-close from 100 microseconds to 1 millisecond respectively. If the relay coil is suppressed, release times are increased. Diode suppression can delay release times for several milliseconds, depending on coil characteristics, coil voltage, and reed release characteristics.

Contact Bounce:

Dry reed contacts bounce on closure as with any other hard contact relay. The duration of bounce on a Dry reed switch is typically very short, and is in part dependent on drive level. In some of the faster devices, the sum of the operate time and bounce is relatively constant. As drive is increased, the operate time decreases with bounce time increasing. The normally closed contacts of a SPDT switch bounce more than the normally open contacts. Magnetically biased SPST-NC contacts exhibit essentially the same bounce characteristics as SPST-NO switches.

Electromechanical Printed Circuit Board Relays – Application Data

Contact Resistance:

The reeds (blades) in a dry reed switch are made of a magnetic material which has a high volume resistivity; terminal-to-terminal resistance is somewhat higher than in some other types of relays. Typical specification limits for initial resistance of a SPST-NO reed relay is 0.200 ohms max (200 milliohms).

Insulation Resistance:

A dry reed switch will have an insulation resistance of 10^{12} to 10^{13} ohms or greater. When it is assembled into a relay, parallel insulation paths reduce this to typical values of 10^{13} ohms. Exposure to high humidity or contaminating environments can appreciably lower final insulation resistance.

Thermal EMF:

Since thermally generated voltages result from thermal gradients within the relay assembly, relays built to minimize this effect often use sensitive switches to reduce required coil power, and thermally conductive materials to reduce temperature gradients.

Noise:

Noise is defined as a voltage appearing between terminals of a switch for a few milliseconds following closure of the contacts. It occurs because the reeds (blades) are moving in a magnetic field and because voltages are produced within them by magnetostrictive effects. From an application standpoint, noise is important if the signal switched by the reed is to be used within a few milliseconds immediately following closure of the contacts. When noise is critical in an application, a peak-to-peak limit must be established by measurement techniques, including filters which must be specified for that particular switching application.

Environmental Characteristics:

Reed relays are used in essentially the same environments as other types of relays. A factor influencing their ability to function would be temperature extremes beyond specified limits.

Vibration:

The reed switch structure, with so few elements free to move, has a better defined response to vibration than other relay types. With vibration inputs reasonably separated from the resonant frequency, the reed relay will withstand relatively high inputs, 20 g's or more. At resonance of the reeds, the typical device can fail at very low input levels. Typical resonance frequency is 2 kHz.

Shock:

Dry reed relays will withstand relatively high levels of shock. SPST-NO contacts are usually rated to pass 30 to 50 g's, 11 milliseconds, half sign wave shock, without false operation of contacts. Switches exposed to a magnetic field that keep the contacts in a closed position, such as in the biased latching form, demonstrate somewhat lower resistance to shock. Normally closed contacts of mechanically biased SPDT switches may also fail at lower shock. Normally closed contacts of mechanically biased SPDT switches may also fail at lower shock levels.

Temperature:

Differential expansion or contraction of reed switches and materials used in relay assemblies can lead to fracture of the switches. Reed relays are capable of withstanding temperature cycling or temperature shock over a range of at least -50°C to $+100^{\circ}\text{C}$. These limits should be applied to the application to prevent switch failure.

Contact Protection:

Tungsten lamp, inductive and capacitive discharge load are extremely detrimental to reed switches and reduce life considerably. Illustrated below are typical suppression circuits which are necessary for maximum contact life.

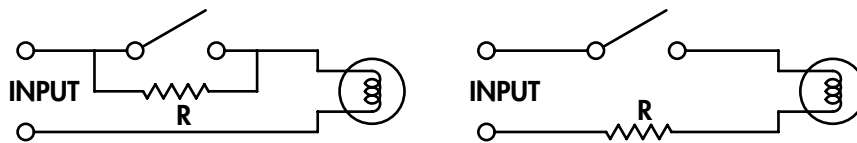

Figure 2

Initial cold filament turn-on current is often 16 times higher than the rated operating current of the lamp. A current limiting resistor in series with the load, or a bleeder resistor across the contacts will suppress the inrush current. The same circuits can be used with capacitive loads, as shown in Figure 2.

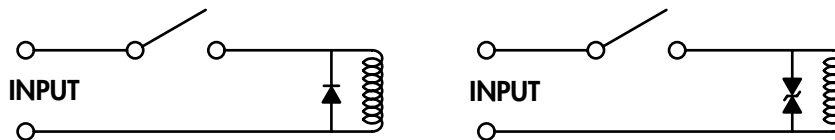

Figure 3

DC inductive loads call for either a diode or a thyristor to be placed across the load. These circuits are necessary to protect the contacts when inductive loads are to be switched in a circuit, as shown in Figure 3.

Advantages of the PCB Relays

Some control system designs require the relay to be mounted directly on the Printed Circuit Board (PCB). These parts will need to be small enough to make PCB mounting practical and more easy to manufacture. The Magnecraft PCB-mounted relays can fit a variety of applications. The line is perfect for low level DC switching and some can handle AC switching. Also, many are rated for UL approved industrial applications.

- DTL Compatible
- Up to 5kV of Surge Resistance Coils
- UL Recognized for 1/6 HP 120VAC Model



276



976

- Up to 20A
- Less than 1 Cubic Inch
- UL Recognized and meets CSA and TÜV Specifications

SIPS & DIPS

Electronic control circuits built on PCB's demand relays that can be populated with the same machinery currently used in the production lines. The Magnecraft SIPS and DIPS are built in small industry standard package styles that do not require unique machinery to populate. The SIPS and DIPS can even withstand a lead-free solder re-flow process so a pin-thru-paste application is possible.

- Up to 1/3 HP 120VAC Switching
- UL Recognized
- Can Be Configured in a Variety of Contact Materials and Mounting Styles



49



117SIP

- RoHS Compliant
- Designed for Simple Routing on PCB
- Requires only 0.5 Inch Spacing from Adjacent Relays



107DIP

- 50 G Shock Resistance
- RoHS Compliant
- Designed for Simple Routing on PCB



171DIP

- Available with or without Clamping Diode
- SPST-NO and SPST-NC Versions Available
- A Wide Variety of Standard Parts
- RoHS Compliant

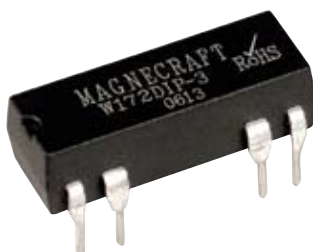

172DIP

- 50 G Shock Resistance
- RoHS Compliant

49 PCB Mount Enclosed Relay/SPDT 3 - 10 Amp Rated

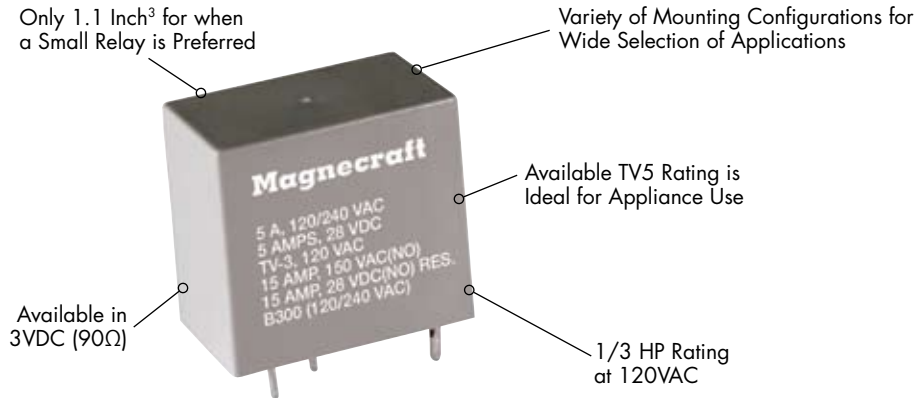

General Specifications

(UL 508)

Contact Characteristics		Units	10 Amp SCO SPDT	
Number and type of Contacts			Normally Open	Normally Closed
Contact materials			Silver Alloy	
Current rating		A	15	10
Switching voltage		~ V	277 V 50/60 Hz	
		≡ V	28 V	
		HP	1/3 @ 240 VAC	1/6 @ 240 VAC
		HP	1/4 @ 277 VAC	1/8 @ 277 VAC
Minimum Switching Requirement		Pilot Duty mA	B300 (120/240 VAC) 100	
Coil Characteristics				
Voltage Range		≡ V	3...24	
Operating Range	% of Nominal	≡	75% to 120%	
Average consumption		≡ W	0.11	
Drop-out voltage threshold		≡	10%	
Performance Characteristics				
Electrical Life	Operations @ Rated Current (Resistive)		100,000	
Mechanical Life	Unpowered		50,000,000	
Operating time (response time)		ms	25	
Dielectric	Between coil and contact	~ V	2500	
	Between contacts	~ V	500	
Environment				
Product certifications	Standard version		UL	
Ambient air temperature around the device	Storage	°C	-40...+85	
	Operation	°C	-40...+55	
Vibration resistance	Operational	g-n	3, 10 to 55 Hz	
Shock resistance		g-n	10	
Weight		grams	42	



5 Amp SCO SPDT			3 Amp Silver SPDT		
Normally Open		Normally Closed	Normally Open		Normally Closed
	Silver Alloy			Fine Silver	
	5		15		3
	120 V 50/60 Hz			150 V 50/60 Hz	
	28 V			28 V	
1/3 @ 240 VAC		1/6 @ 240 VAC	1/3 @ 240 VAC		1/6 @ 240 VAC
1/4 @ 277 VAC		1/8 @ 277 VAC	1/4 @ 277 VAC		1/8 @ 277 VAC
	B300 (120/240 VAC)			B300 (120/240 VAC)	
	100			100	
	3...24		3...24		5...24
	75% to 120%			75% to 120%	
	0.11			0.11	
	10%			10%	
	100,000			100,000	
	50,000,000			50,000,000	
	25			25	
	2500			2500	
	500			500	
	UL			UL	
	-40...+85			-40...+85	
	-40...+55			-40...+55	
	3, 10 to 55 Hz			3, 10 to 55 Hz	
	10			10	
	42			42	

49 PCB Mount Enclosed Relay/SPDT 3 - 10 Amp Rated *continued*

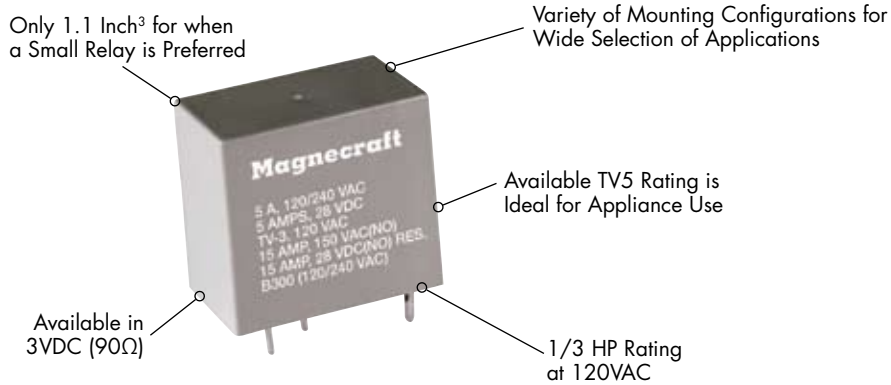

Standard Part Numbers

BOLD-FACED PART NUMBERS ARE NORMALLY STOCKED

Nominal Input Voltage 3 Amp, Style RE1C1	Nominal Coil Resistance (Ω)	Part Number	Contact Configuration
3 VDC	90 Ω	W49RE1C1VG-3DC-SIL	SPDT
5 VDC	235 Ω	W49RE1C1VG-5DC-SIL	SPDT
12 VDC	1350 Ω	W49RE1C1VG-12DC-SIL	SPDT
6 VDC	410 Ω	W49RE1C2VF-6DC-SIL	SPDT
12 VDC	1640 Ω	W49RE1C2VF-12DC-SIL	SPDT
24 VDC	6560 Ω	W49RE1C2VF-24DC-SIL	SPDT
5 Amp, Style RE1C1 and RE1C2			
5 VDC	235 Ω	W49RE1C1VG-5DC-SCO	SPDT
12 VDC	1350 Ω	W49RE1C1VG-12DC-SCO	SPDT
24 VDC	5400 Ω	W49RE1C1VG-24DC-SCO	SPDT
6 VDC	410 Ω	W49RE1C2VF-6DC-SCO	SPDT
12 VDC	1640 Ω	W49RE1C2VF-12DC-SCO	SPDT
24 VDC	6560 Ω	W49RE1C2VF-24DC-SCO	SPDT
10 Amp, Style RE1C1			
5 VDC	100 Ω	W49RE1C1VW-5DC-SCO	SPDT
12 VDC	600 Ω	W49RE1C1VW-12DC-SCO	SPDT
24 VDC	2400 Ω	W49RE1C1VW-24DC-SCO	SPDT
10 Amp, Style R1C4			
5 VDC	235 Ω	W49R1C4VG-5DC-SCO	SPDT
12 VDC	1350 Ω	W49R1C4VG-12DC-SCO	SPDT
10 Amp, Style R1C4			
5 VDC	100 Ω	W49R1C4VW-5DC-SCO	SPDT
24 VDC	2400 Ω	W49R1C4VW-24DC-SCO	SPDT

Part Number Builder

Series	Footprint	Rating	Coil Voltage	Contact Material
49	RE1C1 = Narrow Footprint RE1C2 = Wide Footprint R1C4 = Top Mounting Bracket	VG = (RE1C1) 5A SCO or 3A Fine Silver VG (R1C4) = 10A SCO VF = (RE1C2) 5A SCO or 3A Fine Silver VW = 10A SCO	3DC = 3 VDC 5DC = 5 VDC 6DC = 6 VDC 12DC = 12 VDC 24DC = 24 VDC	SIL = Fine Silver Contacts SCO = Silver Alloy Contacts

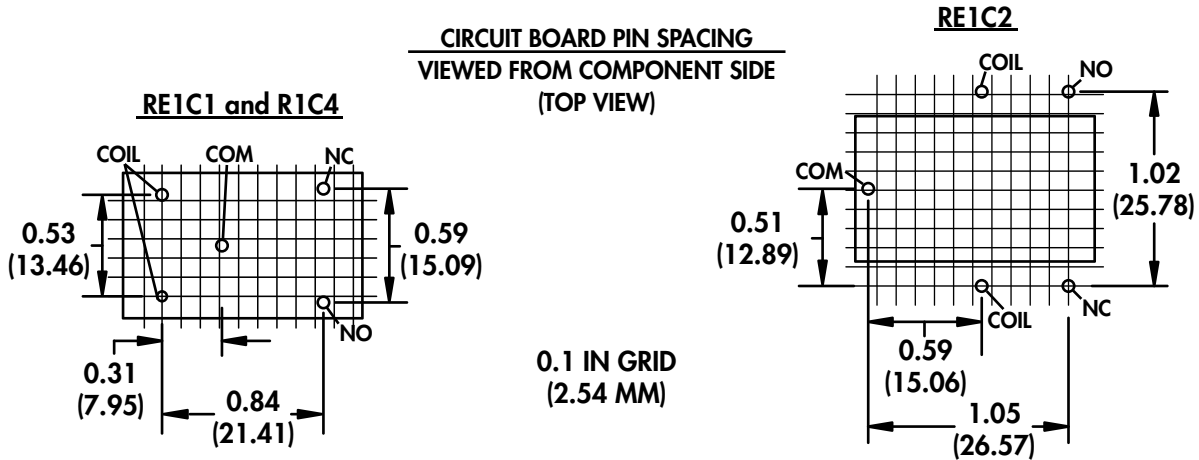

STYLE RE1C1

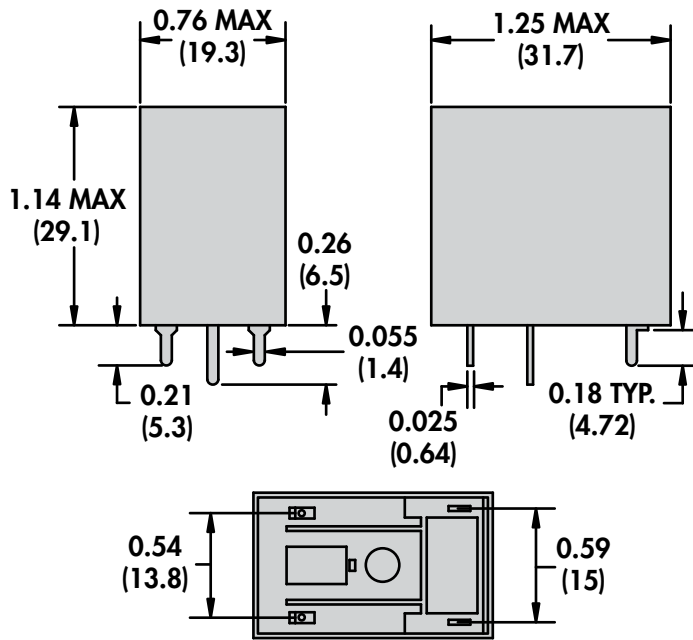

STYLE RE1C2

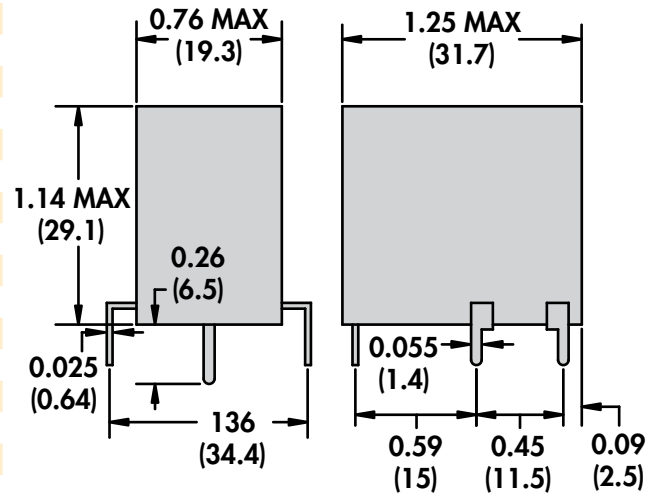

STYLE R1C4

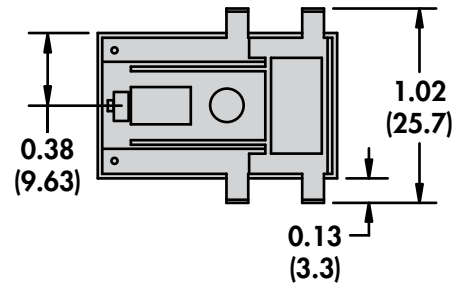
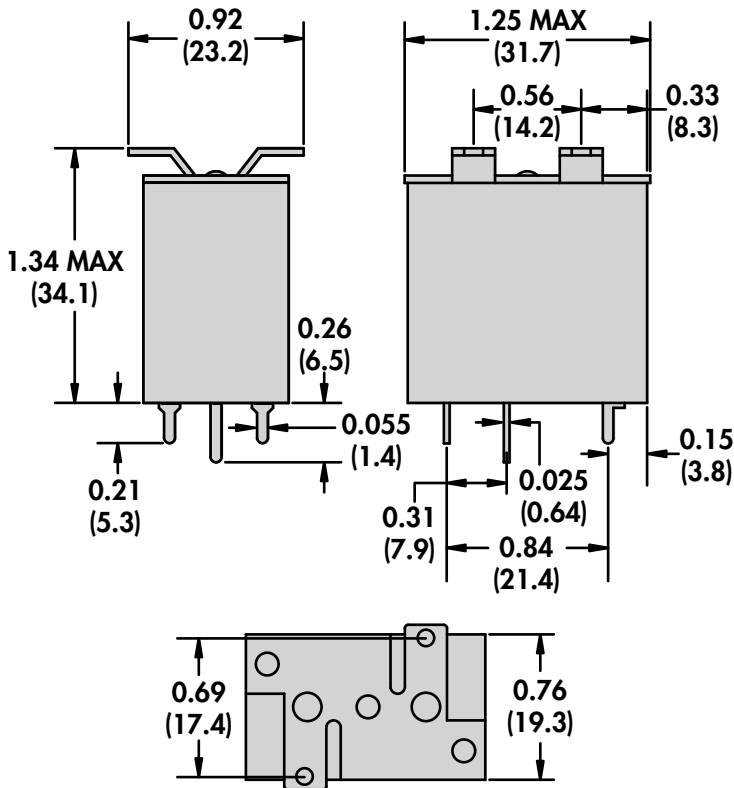

**WIRING DIAGRAMS
TOP VIEW**

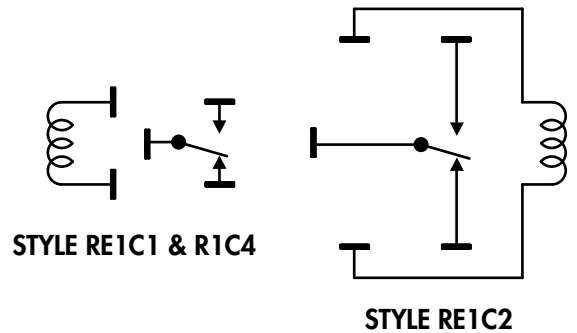

DRAWINGS SHOWN AT 100% OF ACTUAL SIZE