

K42 Series Dimensions

Dimensions in mm

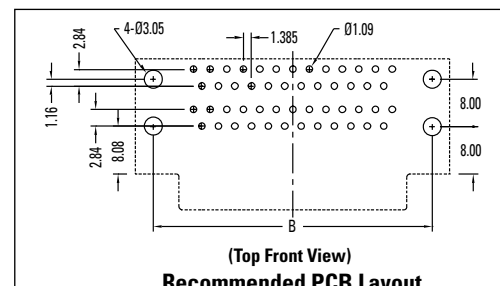
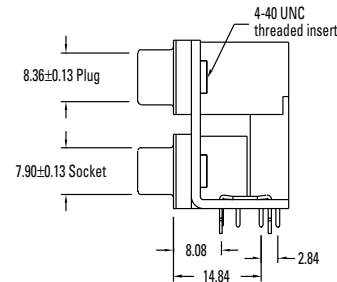
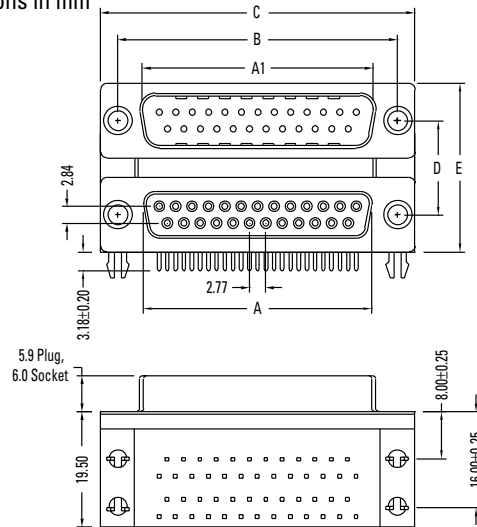

**K42 Series
Dual-Port D-Sub**

Ordering Information

K42	-	B	25	P	/	S	-	A	4N
Series	Shell	Number	Top	Bottom	Center	Mounting	Plating		
	Size	of	Connector	Connector	to Center	Options	Options		
		Contacts	Gender	Gender	Distance				

Series

K42 - Kycon Dual-Port D-Subminiature Connector

Shell Size

E - 9 Contacts

A - 15 Contacts

B - 25 Contacts

C - 37 Contacts

Number of Contacts Per Port

9, 15, 25, 37

Top Connector Gender

P - Pin Contact (Plug)

S - Socket Contact (Receptacle)

Bottom Connector Gender

P - Pin Contact (Plug)

S - Socket Contact (Receptacle)

Center to Center Distance

A - .750"

B - .900"

C - .625"

Mounting Options (see page 37)

Plating Options and Performance Specifications (see page 4)

Number of Contacts (Shell Size)	Dimensions (Inch/mm)			
	A	A1	B	C
9 (E)	.643 16.33	.666 16.92	.984 24.99	1.213 30.81
15 (A)	.971 24.66	.994 25.25	1.312 33.32	1.541 39.14
25 (B)	1.511 38.38	1.534 38.96	1.852 47.04	2.088 53.04
37 (C)	2.159 54.84	2.181 55.42	2.500 63.50	2.729 69.32

Center to Center Spacing	D	E
A	.750 19.05	1.244 31.60
B	.900 22.86	1.394 35.41
C	.625 15.88	1.119 28.42

A = Exterior of Female Shell (S)

A1 = Interior of Male Shell (P)

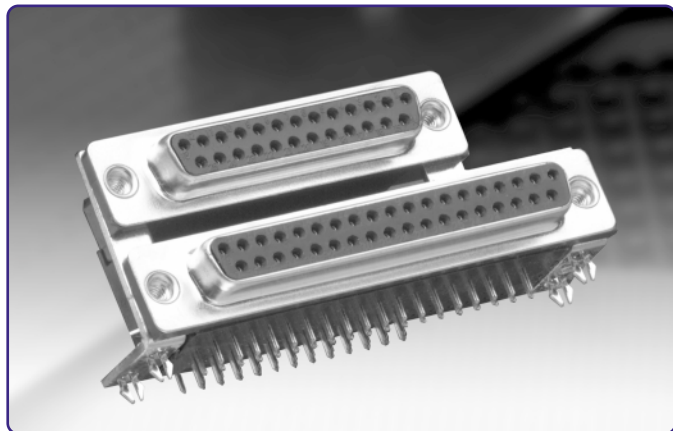

K42 Series Combination Multiport D-Subminiature

Ordering Information

K42-B25S/E9P-A4N	25 Pin Female over 9 Pin Male, .750" Center to Center Spacing
K42-B25S/E9P-B4N	25 Pin Female over 9 Pin Male, .900" Center to Center Spacing
K42-B25S/E9P-C4N	25 Pin Female over 9 Pin Male, .625" Center to Center Spacing
K42-B25S/E15S-A4N	25 Pin Female over 15 Pin High Density Female, .750" Center to Center Spacing
K42-B25S/E15S-B4N	25 Pin Female over 15 Pin High Density Female, .900" Center to Center Spacing
K42-B25S/E15S-C4N	25 Pin Female over 15 Pin High Density Female, .625" Center to Center Spacing
K42-E9P/E15S-A4N	9 Pin Male over 15 Pin Female High Density
K42-25/9-9-A4N	25 Pin Female over Two 9 Pin Males
K42-25/9-15-A4N	25 Pin Female over 9 Pin Male and 15 Pin High Density Female
K42-25/15-9-A4N	25 Pin Female over 15 Pin High Density Female and 9 Pin Male
K42-B25SL/C37S-C4N	Offset 25 Pin Female over 37 Pin Female
K42-E15S/S-A4N	15 Pin High Density Female over 15 Pin High Density Female

Plating Options

Designator	Plating Description
Standard	Gold flash over nickel on contacts. Tin/lead over nickel on soldertails.
15	15µ" gold over nickel on mating end of contacts. Tin/lead over nickel on soldertails.
30	30µ" gold over nickel on mating end of contacts. Tin/lead over nickel on soldertails.

Performance Specifications (see page 4)

K42 Series Dimensions

Dimensions in mm

K42-B25S/E9P-A4N

K42-B25S/E9P-B4N

K42-B25S/E9P-C4N

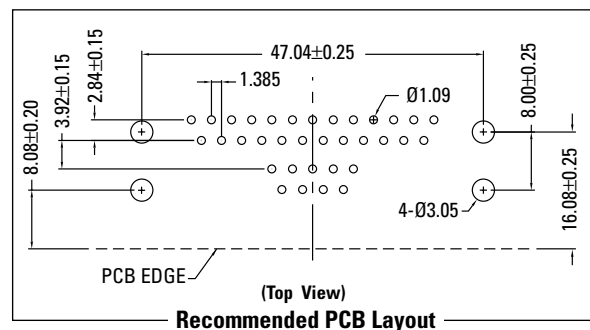
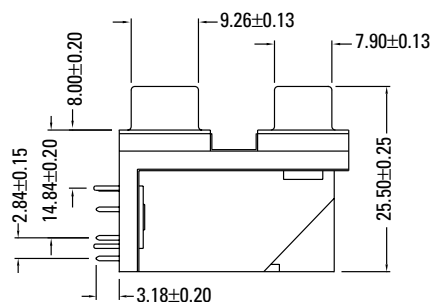
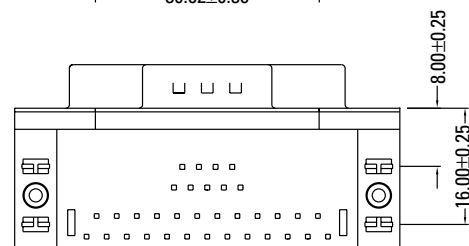
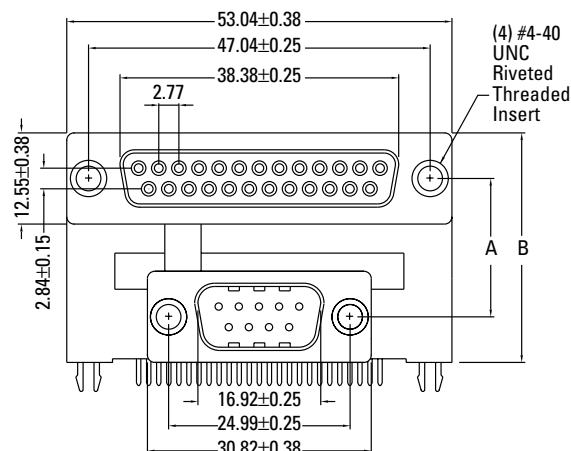

Center to Center Spacing	Dimensions (Inch/mm)	
	A	B
A	.750/19.05	1.244/31.60
B	.900/22.86	1.394/35.41
C	.625/15.88	1.119/ 28.42

K42 Series Dimensions

Dimensions in mm

K42-B25S/E15S-A4N

K42-B25S/E15S-B4N

K42-B25S/E15S-C4N

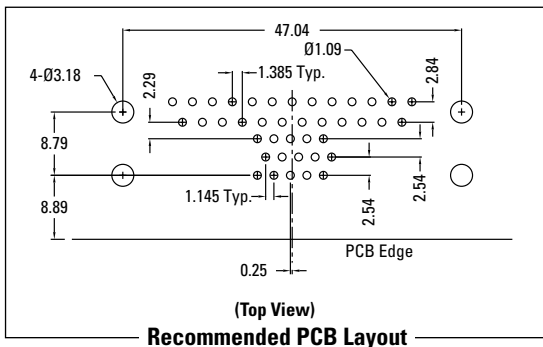
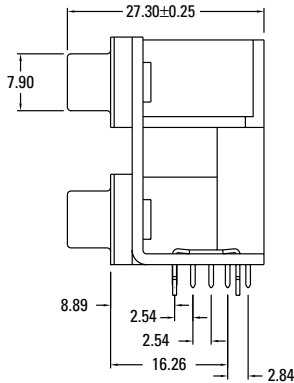
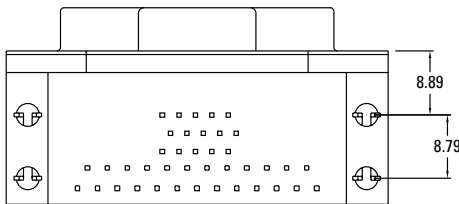
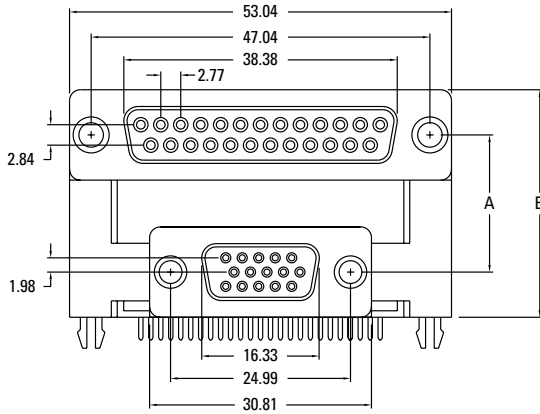

Dimensions (Inch/mm)		
Center to Center Spacing	A	B
A	.750 / 19.05	1.244 / 31.60
B	.900 / 22.86	1.394 / 35.41
C	.625 / 15.88	1.119 / 28.42

MULTIPOINT D-SUBMINIATURE

K42 Series

K42-E9P/E15S-A4N

Dimensions in mm

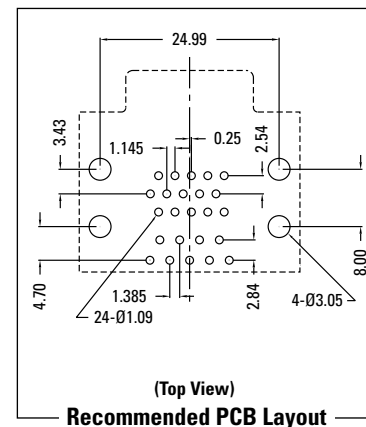
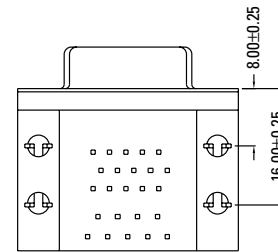
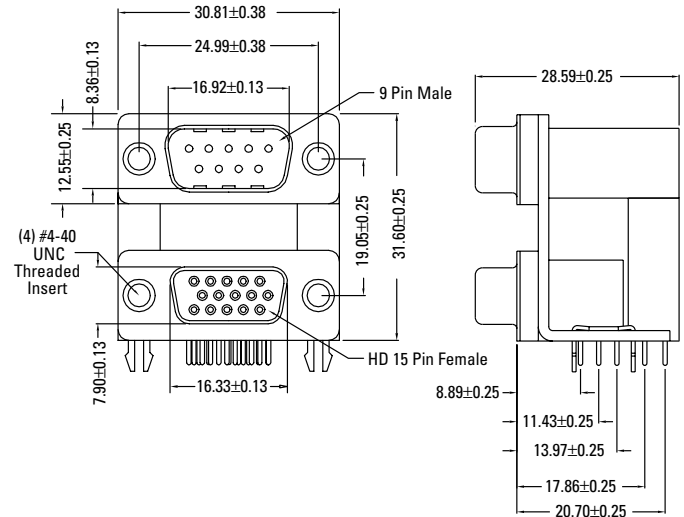

K42 Series Dimensions

Dimensions in mm

K42-E15S/S-A4N

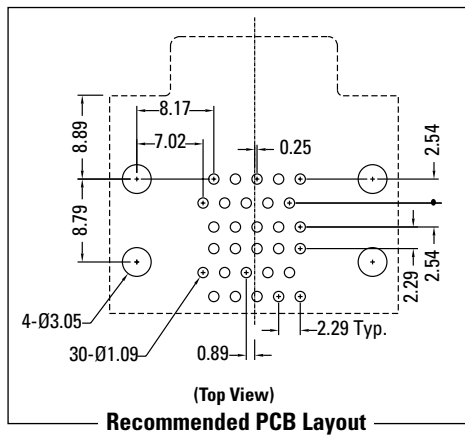
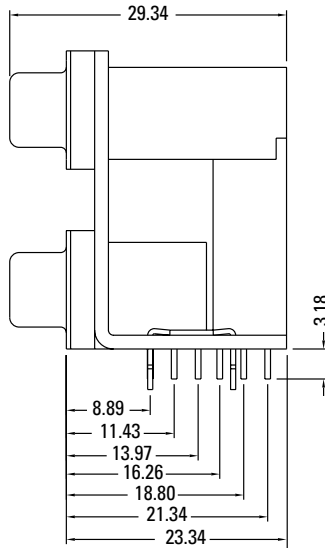
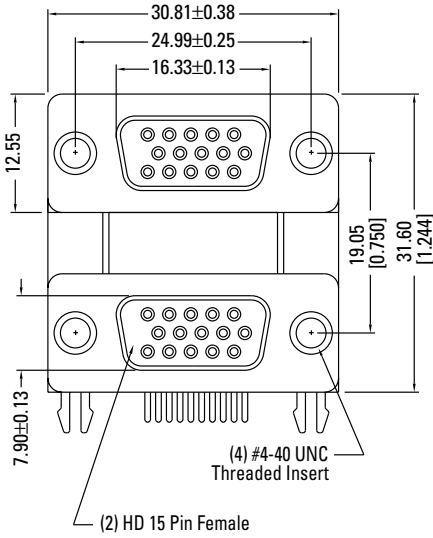

MULTIPOINT D-SUBMINIATURE

K42 Series

K42-B25SL/C37S-C4N

Dimensions in mm

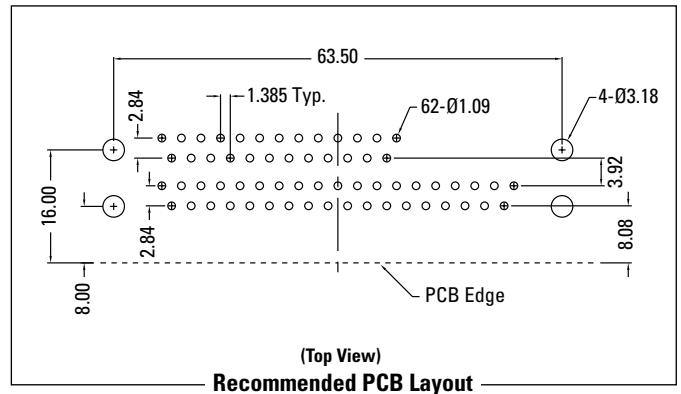
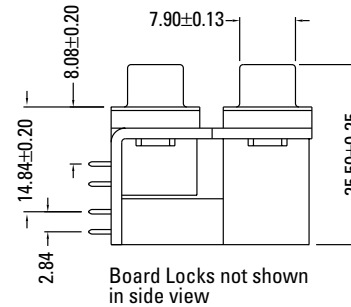
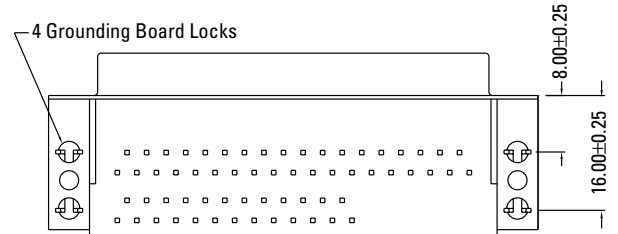
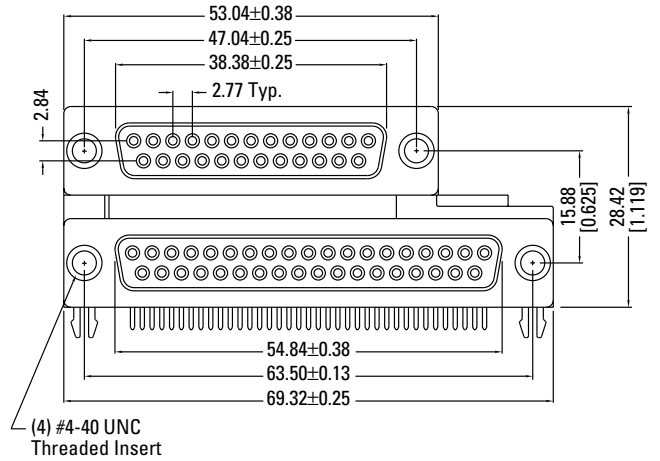

K42 Series Dimensions

K42-25/9-9-A4N

Dimensions in mm

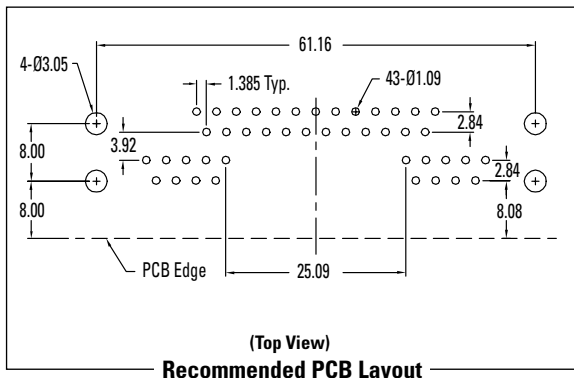
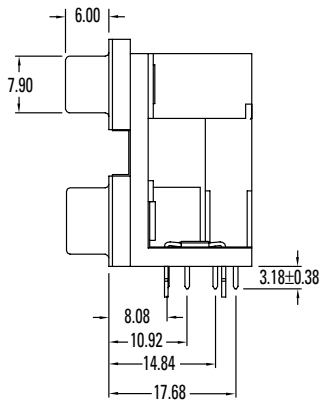
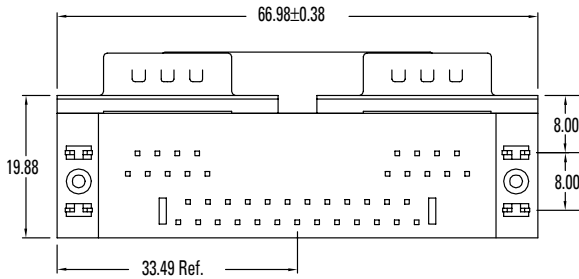
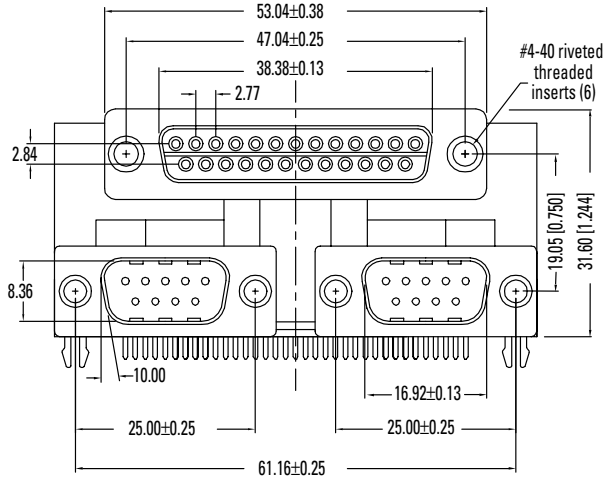

MULTIPOINT D-SUBMINIATURE

K42 Series

K42-25/15-9-A4N

Dimensions in mm

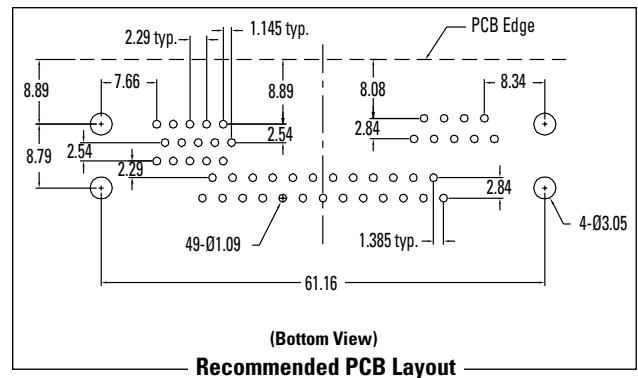
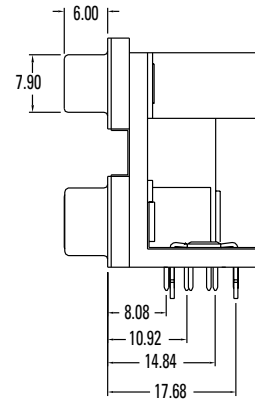
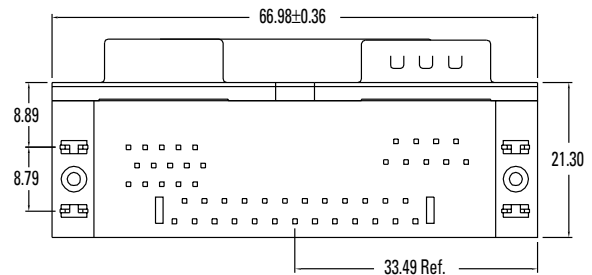
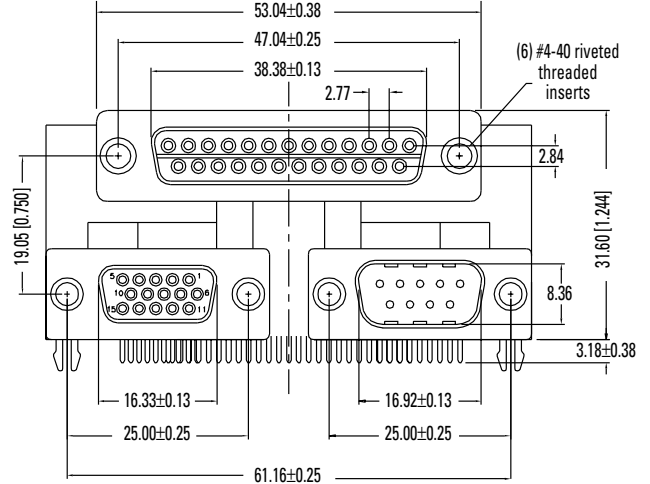

Mounting Options K42, KF42

Standard

With .125 Diameter Mounting Holes and 4-40 Riveted Threaded Inserts

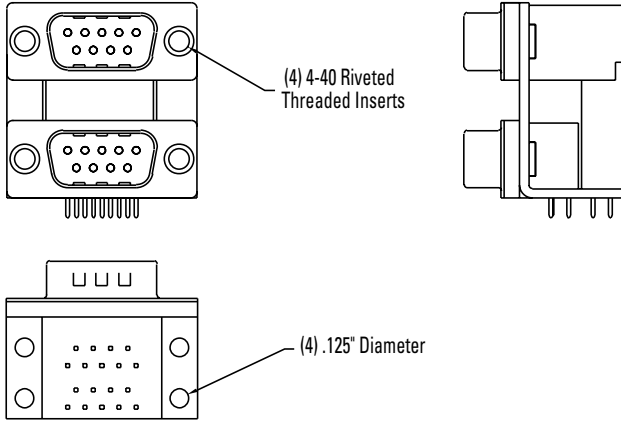

J

With .125 Diameter Mounting Holes and 4-40 Hex Jack Screws Installed

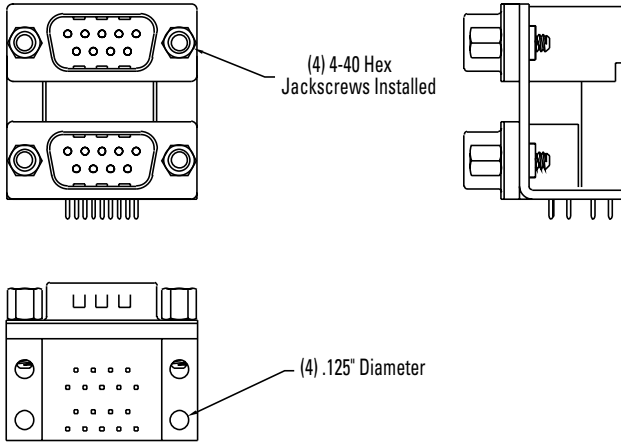

R

With .125 Diameter Mounting Holes and 4-40 Round Jack Screws Riveted to Connector

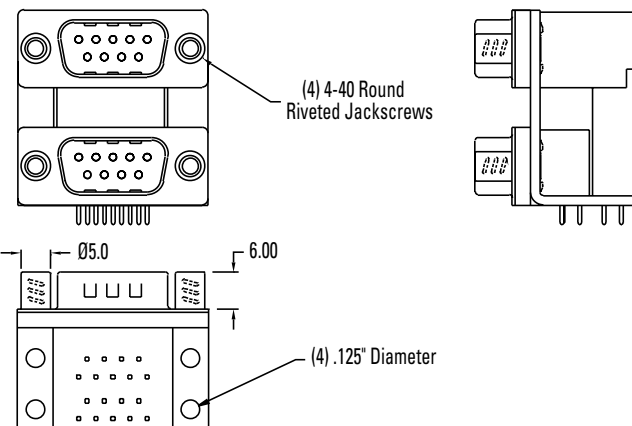

4N

With Four Board Locks and 4-40 Riveted Threaded Inserts

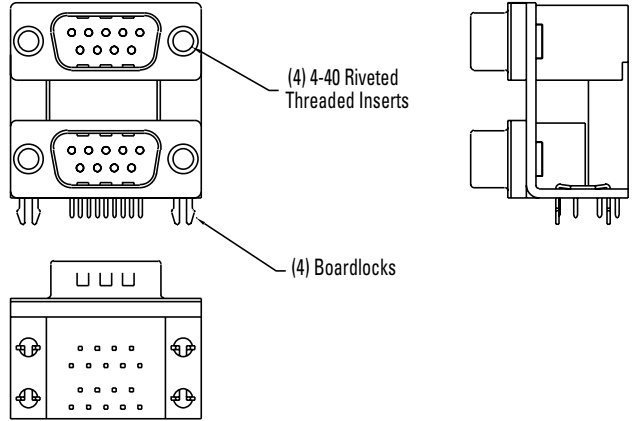

4NJ

With Four Board Locks and 4-40 Hex Jack Screws Installed

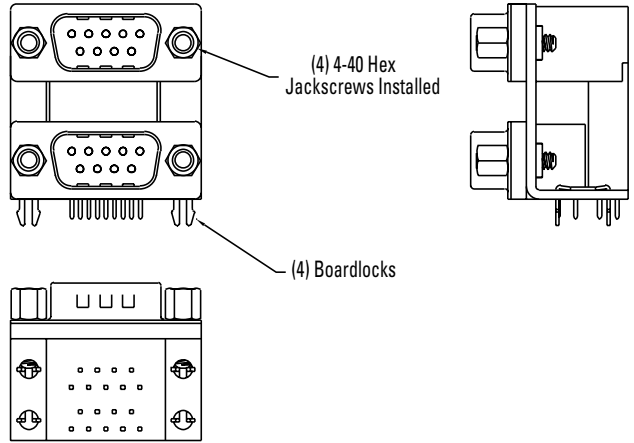

4NR

With Four Board Locks and 4-40 Round Jack Screws Riveted to Connector

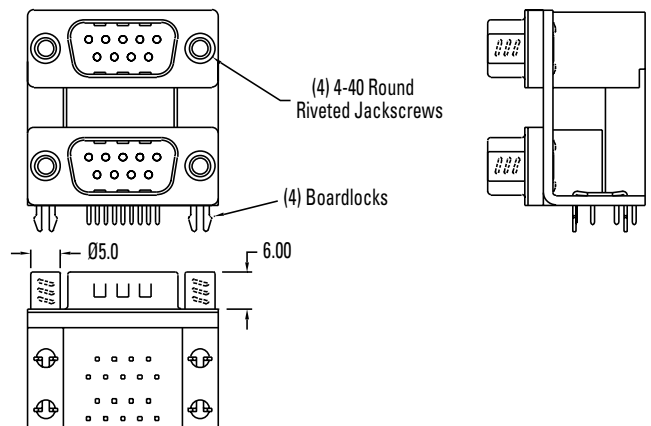

KYCON continues its leadership in D-Subminiature connectors by offering a complete line of sizes and options.

PC99 Colors Available:

- HD15: Blue
- DB15: Gold
- DB25: Burgundy
- DB09: Teal



D-SUBMINIATURE CONNECTORS

Performance Specifications

Materials and Finish

Shell

Steel Material, Tin Finish, and Indentations (Dimples) on Plug Only

Insert

Standard: PBT Thermoplastic, Black Color, 30% Glass Filled, 94V-0 Rated
 Reflow Compatible: High Temperature Thermoplastic, Black Color, 30% Glass Filled, 94V-0 Rated

Contact Material

Pin: Brass .040 (1.02) Diameter Standard; .030 (0.76) Diameter High Density
 Socket: Phosphor Bronze (Precision Formed Contact)
 Brass (Precision Machined Contact)

Contact Finish-Standard

Gold Flash Over 0.0001 (0.00254) Nickel on Mating End of Contacts
 Tin/Lead Over Nickel or Gold Flash Over Nickel on Solder Tails

Riveted Insert

Brass Material, Nickel Finish

Mechanical Characteristics

Contact Retention

Precision Machined Contact 10 Lbs, Precision Formed Contact 10 Lbs

Contact Extraction Force

Typ. 4 Oz.

Contact Insertion Force

Typ. 9 Oz.

Durability

1,000 Insertion Cycles Min (With Standard Plating)

Operating Temperature Rating

-55°C to +125°C

Electrical Characteristics

Contact Current Rating

Precision Machined Contact 7.6 Amps
 Precision Formed Contact 5.0 Amps (Except K99 Series)

Contact Resistance

Precision Machined Contact 5 Milliohms Max
 Precision Formed Contact 8 Milliohms Max

Dielectric Withstanding Voltage

1000 V AC Min for 1 Minute

Insulation Resistance

5000 Megohms Min

Processing Characteristics

Soldering Temperature Rating

High Temperature Plastic: 230°C for 30 Seconds, 260°C for 10 Seconds

Plating Options

Designator	Plating Description
Standard	Gold Flash over Nickel on Contacts. Gold Flash over Nickel or Tin/Lead over Nickel on Solder Tails.
15	15µ" Gold over Nickel on Mating End of Contacts. Tin/Lead over Nickel on Solder Tails.
30	30µ" Gold over Nickel on Mating End of Contacts. Tin/Lead over Nickel on Solder Tails.