

Ø 6,77" x 1,968" Ø 172 x 50 mm

Series 354D
S, X, Z
speeds

ETRI®
DC Axial Fans

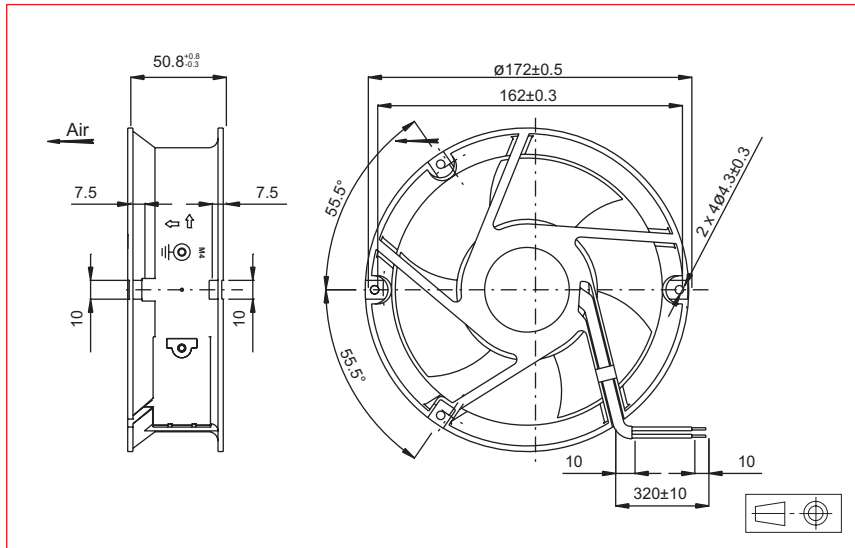

Approvals



Life expectancy

L-10 LIFE AT 40°C:
80 000 hours

Brushless DC Motor

Electrical protection: impedance protected
Housing material: aluminium
Impeller material: plastic UL 94 VO
Weight: 840 g
Bearing system: ball bearings

Available with:

- Speed sensor
- Alarm
- IP54 / IP55

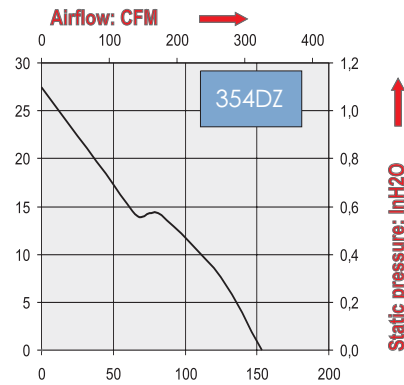
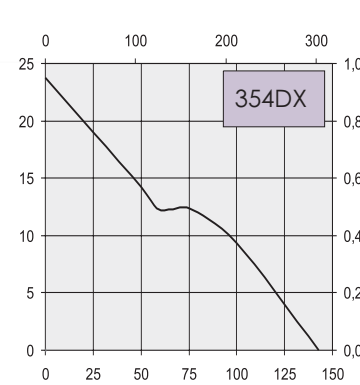
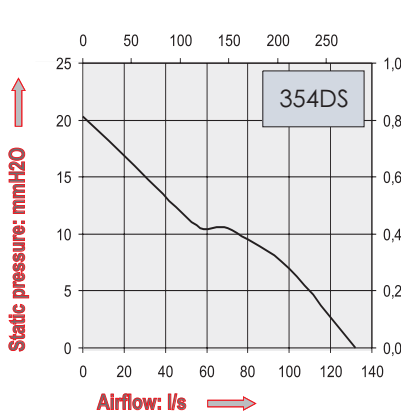

Part Number	Nominal voltage	Airflow	Noise level	Nominal speed	Input Power	Voltage range	Connection type		Operating temperature	
	V	l/s	dB(A)	RPM	W	V	Leads	Terminals	Min.°C	Max.°C
354DS1LM11000	12	132,0	57,5	3700	25,3	(8-14)	X		-10	70
354DS2LM11000	24	132,0	57,5	3700	20,4	(12-28)	X		-10	70
354DS4LM11000	48	132,0	57,5	3700	23,5	(24-56)	X		-10	70
354DX2LM11000	24	142,7	60	4000	26,4	(12-28)	X		-10	70
354DX4LM11000	48	142,7	60	4000	30,7	(24-56)	X		-10	70
354DZ2LM11000	24	153,3	63	4300	32,9	(12-28)	X		-10	70

Additional versions:
Lower speeds (Refer to page 35)

Accessories:
Refer to Accessories leaflet