

SF RELAYS Double contact type

Flat type (double contact) Safety relay compliant with Safety standards

[Protective construction] Sealed type

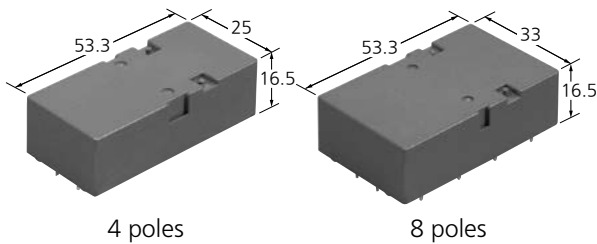

4 poles

8 poles

(Unit: mm)

FEATURES

- High contact reliability is achieved by double contact.
- Forced operation method
- Separate chamber method
- Independent operation method (4 Form A 4 Form B)

TYPICAL APPLICATIONS

- Industrial equipment
- Elevator etc.

ORDERING INFORMATION (PART NO. : Ordering part number for Japanese market)

AG 1 0

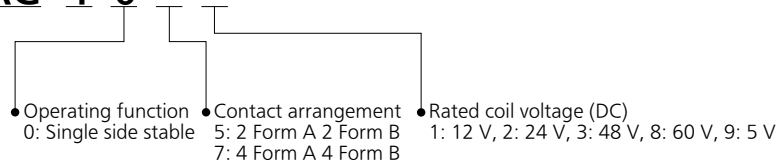

ORDERING INFORMATION (TYPE NO. : Ordering part number for non Japanese market)

SF □ D-□

- Rated coil voltage
DC 5, 12, 24, 48, 60 V
- Contact arrangement
2: 2 Form A 2 Form B
4: 4 Form A 4 Form B

Safety Relays SF RELAYS Double contact type

TYPES

" Type No. " is ordering part number for non Japanese market. " Part No. " is ordering part number for Japanese market.

■ PC board terminal

● Carton packing

Contact arrangement		Rated coil voltage	Type No.	Part No.	Standard packing	
					Inner carton	Outer carton
4 poles	2 Form A 2 Form B	5 V DC	SF2D-DC5V	AG1059	20 pcs.	200 pcs.
		12 V DC	SF2D-DC12V	AG1051		
		24 V DC	SF2D-DC24V	AG1052		
		48 V DC	SF2D-DC48V	AG1053		
		60 V DC	SF2D-DC60V	AG1058		
8 poles	4 Form A 4 Form B	5 V DC	SF4D-DC5V	AG1079		
		12 V DC	SF4D-DC12V	AG1071		
		24 V DC	SF4D-DC24V	AG1072		
		48 V DC	SF4D-DC48V	AG1073		
		60 V DC	SF4D-DC60V	AG1078		

RATING

■ Coil data

- Operating characteristics such as "Operate voltage" and "Release voltage" are influenced by mounting conditions or ambient temperature, etc.
Therefore, please use the relay within $\pm 5\%$ of rated coil voltage.
- "Initial" means the condition of products at the time of delivery.

Contact arrangement		Rated coil voltage	Operate voltage* (at 20°C)	Release voltage* (at 20°C)	Rated operating current ($\pm 10\%$, at 20°C)	Coil resistance ($\pm 10\%$, at 20°C)	Rated operating power	Max. allowable voltage (at 60°C)
4 poles	2 Form A 2 Form B	5 V DC	Max. 75% V of rated coil voltage (Initial)	Min. 10% V of rated coil voltage (Initial)	100 mA	50 Ω	500 mW	120% V of rated coil voltage
		12 V DC			41.7 mA	288 Ω		
		24 V DC			20.8 mA	1,152 Ω		
		48 V DC			10.4 mA	4,608 Ω		
		60 V DC			8.3 mA	7,200 Ω		
8 poles	4 Form A 4 Form B	5 V DC	Max. 75% V of rated coil voltage (Initial)	Min. 15% V of rated coil voltage (Initial)	100 mA	50 Ω	500 mW	
		12 V DC			41.7 mA	288 Ω		
		24 V DC			20.8 mA	1,152 Ω		
		48 V DC			10.4 mA	4,608 Ω		
		60 V DC			8.3 mA	7,200 Ω		

* square, pulse drive (JIS C 5442)

Safety Relays SF RELAYS Double contact type

Specifications

Item		Specifications	
Contact data	Contact arrangement	2 Form A 2 Form B	4 Form A 4 Form B
	Contact resistance (initial)	Max. 30 mΩ (by voltage drop 6 V DC 1 A)	
	Contact material	Au-flashed AgSnO ₂ type	
	Contact rating (resistive)	6 A 250 V AC, 6 A 30 V DC	
	Max. switching power (resistive)	1,500 VA, 180 W	
	Max. switching voltage	440 V AC, 30 V DC	
	Max. switching current	6 A	
	Min. switching load (reference value) *1	100 mA 5 V DC	
Insulation resistance (initial)		Min. 1,000 MΩ (at 500 V DC, Measured portion is the same as the case of dielectric strength.)	
Dielectric strength (initial)	Between open contacts	1,300 Vrms for 1 min (detection current: 10 mA)	
	Between contact sets	2,500 Vrms for 1 min (detection current: 10 mA)	
	Between contact and coil	2,500 Vrms for 1 min (detection current: 10 mA)	
Time characteristics (initial)	Operate time	Max. 30 ms at rated coil voltage (at 20°C, without bounce)	
	Release time	Max. 15 ms at rated coil voltage (at 20°C, without bounce, without diode)	
Shock resistance	Functional	294 m/s ² (half-sine shock pulse: 11 ms, detection time: 10 μs)	
	Destructive	980 m/s ² (half-sine shock pulse: 6 ms)	
Vibration resistance	Functional	10 to 55 Hz at double amplitude of 2 mm (detection time: 10 μs)	
	Destructive	10 to 55 Hz at double amplitude of 2 mm	
Expected life	Mechanical life	Min. 10 x 10 ⁶ (switching frequency 180 times/min)	
Conditions	Conditions for usage, transport and storage*2	Ambient temperature: -40 to +70°C, Humidity: 5 to 85% RH (Avoid icing and condensation)	
Unit weight		Approx. 38 g	Approx. 47 g

*1. This value is a rough indication of the lower limit at which switching is possible at micro load level.

This value can change due to the switching frequency, environmental conditions, and desired reliability level, therefore it is recommended to check this with the actual load.

*2. For ambient temperature, please refer to the "GUIDELINES FOR RELAY USAGE".

Electrical life

Conditions: Resistive load, switching frequency 20 times/min

Type	Switching capacity	Number of operations
2 Form A 2 Form B, 4 Form A 4 Form B	6 A 250 V AC	Min. 100 x 10 ³

REFERENCE DATA

1. Operate and release times (without diode)

Tested sample: SF2D-DC24V (2 Form A 2 Form B)
Quantity: n = 20

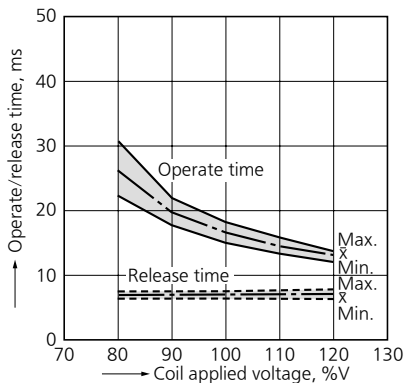

2. Coil temperature rise value

Tested sample: SF4D-DC24V (4 Form A 4 Form B)
Quantity: n = 6
Coil applied voltage: 100%V, 120%V
Contact carry current: 6 A

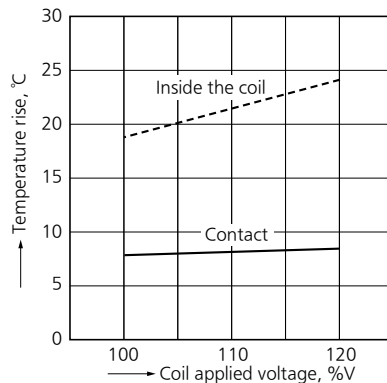

3. Ambient temperature characteristics

Tested sample: SF4D-DC24V (4 Form A 4 Form B)
Quantity: n = 6

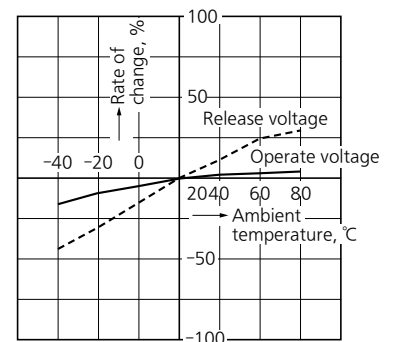

Safety Relays SF RELAYS Double contact type

DIMENSIONS

CAD The CAD data of the products with a "CAD" mark can be downloaded from our Website.

Unit: mm

4 poles (2 Form A 2 Form B)

CAD



External dimensions

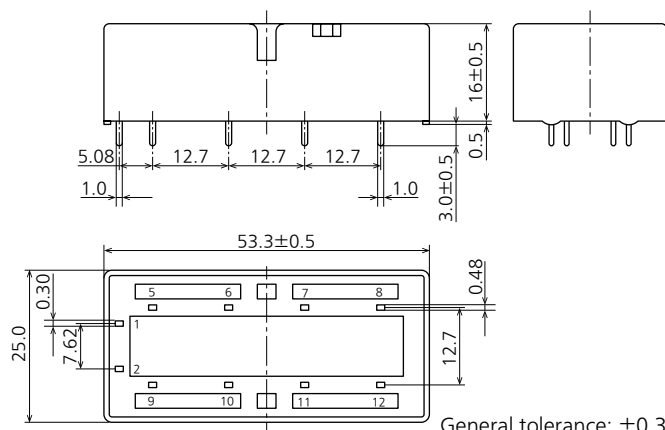

Recommended PC board pattern (BOTTOM VIEW)

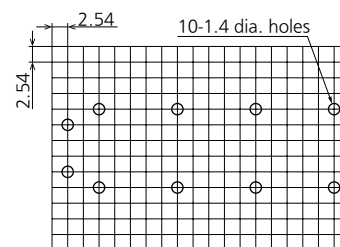

Tolerance: ±0.1

Schematic (BOTTOM VIEW)

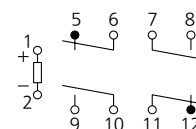

8 poles (4 Form A 4 Form B)

CAD



External dimensions

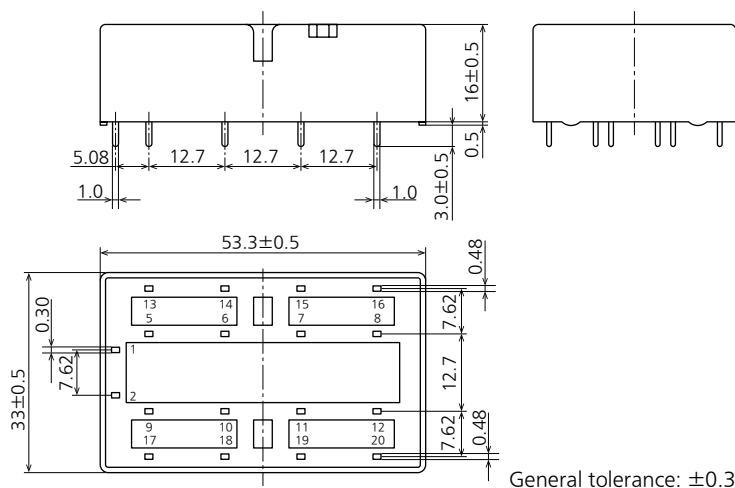

Recommended PC board pattern (BOTTOM VIEW)

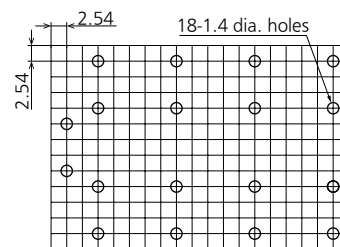

Tolerance: ±0.1

Schematic (BOTTOM VIEW)

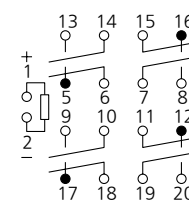

SAFETY STANDARDS

Each standard may be updated at any time, so please check our Website for the latest information.

UL/C-UL (Recognized)

File No.	Contact rating
E120782	6 A 250 V AC
	6 A 24 V DC

TÜV (Certified)

File No.	Contact rating
968/EZ 116.03/10	6 A 250 V AC

CSA (Certified)

CSA standard certified by C-UL

SAFETY STRUCTURE

This SF relay design ensures that subsequent operations shut down and can automatically return to a safe state when the SF relay suffers overloading and other circuit abnormalities (unforeseen externally caused circuit or device breakdowns, end of life incidents, and noise, surge, and environmental

influences) owing to contact welding, spring fusion or, in the worst-case scenario, relay breakdown (coil rupture, faulty operation, faulty return, and fatigue and breakage of the operating spring and return spring), and even in the event of end of life.

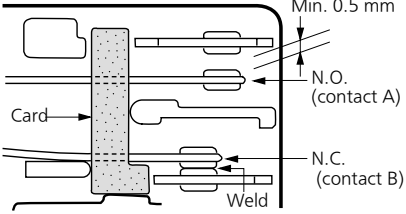
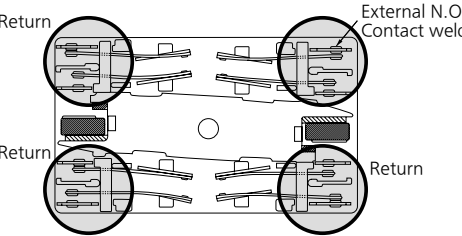
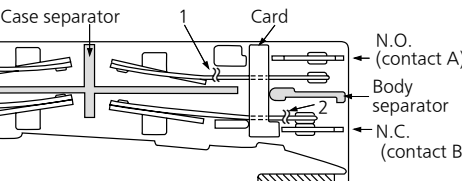
		Structure	Operation
1	Forced operation method (2 Form A 2 Form B, 4 Form A 4 Form B)	 <p>The two form A and B contacts are coupled with the same card. The operation of each contact is regulated by the movement of the other contact.</p>	<p>Even when one contact is welded closed, the other maintains a gap of Min. 0.5 mm.</p> <p>(Example) In the diagram on the left, the form B contact have welded but the form A contact maintain at a gap of 0.5 mm. Subsequent contact movement is suspended and the weld can be detected.</p>
2	Independent operation method (4 Form A 4 Form B)	 <p>None of four contacts are held in position by the armature. Even though one of the external contacts has welded, the other three contacts have returned owing to the de-energizing of the coil.</p>	<p>Enables design of safety circuits that allow weld detection and return at an initial stage.</p> <p>(Example) As shown at the top right of the diagram on the left, if the external N.O. contact welds, a 0.5 mm gap is maintained. Each of the other three contacts returns to N.O. because the coil is no longer energized.</p>
3	Separate chamber method (2 Form A 2 Form B, 4 Form A 4 Form B)	 <p>In independent chambers, the form A and B contacts are kept apart by a body/separator of card and by the card itself.</p>	<p>Prevents shorting between contacts and welding of springs and spring failure owing to short circuit current.</p> <p>(Example) As shown on the diagram on the left, even if the operating springs numbered 1 and 2 there is no shorting between contacts.</p>
4	2 Form A 2 Form B contact, 4 Form A 4 Form B contact	<p>Contact arrangement with independent COM contact (2 Form A 2 Form B), (4 Form A 4 Form B)</p>	<p>Independent COM enables differing pole circuit configurations. This makes it possible to design various kinds of control circuits and safety circuits.</p>

Safety Relays SF RELAYS Double contact type

OPERATION (WHEN CONTACTS ARE WELDED)

SF relays work to maintain a normal operating state even when the contact welding occur by overloading or short circuit currents.

It is easy to make weld detection and safety circuit in the design to ensure safety even if contacts weld.

■ 4 poles (2 Form A 2 Form B)

● Form B contact welding

When the form B contact (No. 1 or No. 3) weld, the armature becomes non-operational, the contact gaps at the two form A contacts are maintained at Min. 0.5 mm. Reliable cut-off state is thus ensured.

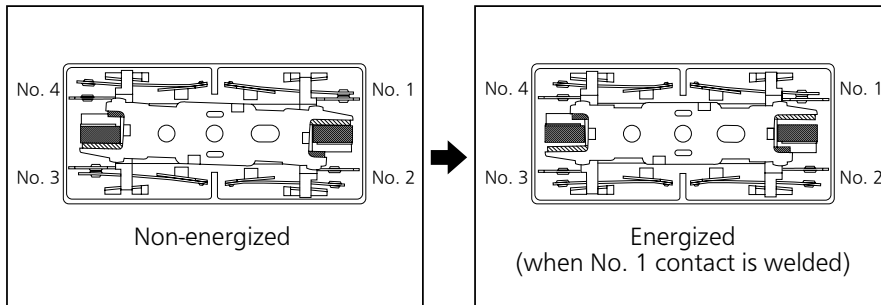

(Example) Case of No. 1 contact welding
Each of the two form A contacts (No. 2 and No. 4) maintain a gap of Min. 0.5 mm.

● Form A contact welding

When the form A contact (No. 2 or No. 4) weld, the armature remains in a non-returned state and the contact gap at the two form B contacts are maintained at Min. 0.5 mm. Reliable cut-off state is thus ensured.

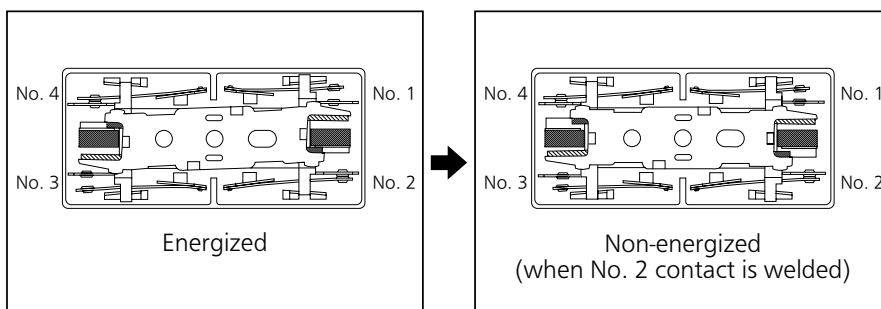

(Example) Case of No. 2 contact welding
The two form B contacts (No. 1 and No. 3) maintains a gap of Min. 0.5 mm.

● Contact operation table

The table below shows the state of the other contacts when the current through the welded form A contact is 0 V and the rated voltage is applied through the welded form B contact.

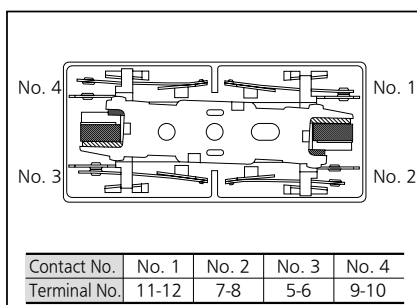

		State of other contacts			
		1	2	3	4
Welded terminal No.	1	—	> 0.5		> 0.5
	2	> 0.5	—	> 0.5	
	3		> 0.5	—	> 0.5
	4	> 0.5		> 0.5	—

> 0.5: Contact gap Min. 0.5 mm
Empty cells: either closed or open

Note) Contact gaps are shown at the initial state. If the contacts change state owing to load switching it is necessary to check the actual loading.

Safety Relays SF RELAYS Double contact type

■ 8 poles (4 Form A 4 Form B)

● Internal contacts welding

When internal contacts (No. 2, No. 3, No. 6 or No. 7) are welded, the armature becomes non-operational and the four open contact gaps are maintained at Min. 0.5 mm. Reliable cut-off state is thus ensured.

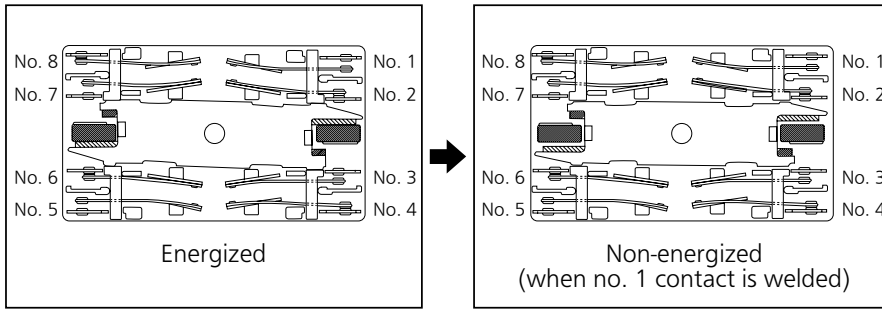

(Example) Case of No. 1 contact welding Each of the four form A contacts (No. 1, No. 3, No. 5 and No. 7) maintains a gap of Min. 0.5 mm.

● External contacts welding

When external contacts (No. 1, No. 4, No. 5 or No. 8) are welded, gap between welded contact and adjacent contact is maintained at Min. 0.5 mm and other contacts operate normally by the coil being non-energized.

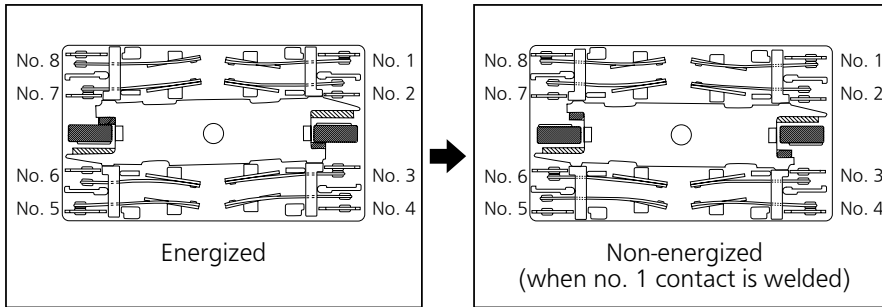

(Example 1) Case of No. 1 contact welding
Adjacent contact No. 2 maintains a contact gap of Min. 0.5 mm. Other contacts go back to the normal return position by coil non-energized, form A contacts (No. 3, No. 5 and No. 7) maintain a contact gap of Min. 0.5 mm, and form B contacts (No. 4, No. 6 and No. 8) return to a conductive state.

(Example 2) Case of external connections are made in series
Even if one of the contacts welds, the other contacts operate independently and the contact gaps are maintained at Min. 0.5 mm.

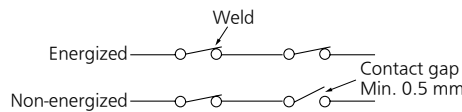

● Contact operation table

The table below shows the state of the other contacts when the current through the welded form A contact is 0 V and the rated voltage is applied through the welded form B contact.

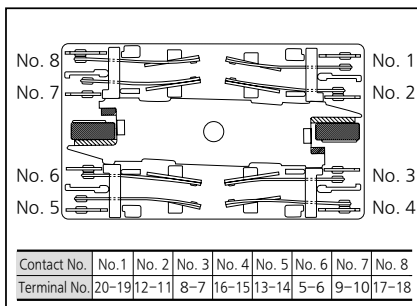

		State of other contacts							
		1	2	3	4	5	6	7	8
Welded terminal No.	1	—	> 0.5	> 0.5	≠	> 0.5	≠	> 0.5	≠
	2	> 0.5	—	> 0.5		> 0.5		> 0.5	
	3		> 0.5	—	> 0.5		> 0.5		> 0.5
	4	≠	> 0.5	> 0.5	—	≠	> 0.5	≠	> 0.5
	5	> 0.5	≠	> 0.5	≠	—	> 0.5	> 0.5	≠
	6	> 0.5		> 0.5		> 0.5	—	> 0.5	
	7		> 0.5		> 0.5		> 0.5	—	> 0.5
	8	≠	> 0.5	≠	> 0.5	≠	> 0.5	> 0.5	—

> 0.5: Contact gap Min. 0.5 mm
≠: contact closed

Empty cells: either closed or open

Note) Contact gaps are shown at the initial state. If the contacts change state owing to load switching it is necessary to check the actual loading.

GUIDELINES FOR USAGE

■ For cautions for use, please read "GUIDELINES FOR RELAY USAGE".

https://industrial.panasonic.com/ac/e/control/relay/cautions_use/index.jsp

GUIDELINES FOR POWER, HIGH-CAPACITY DC CUT OFF AND SAFETY RELAYS USAGE

■ For cautions for use, please read “GUIDELINES FOR RELAY USAGE”.
https://industrial.panasonic.com/ac/e/control/relay/cautions_use/index.jsp

Precautions for Coil Input

■ Long term current carrying

A circuit that will be carrying a current continuously for long periods without relay switching operation. (circuits for emergency lamps, alarm devices and error inspection that, for example, revert only during malfunction and output warnings with form B contacts)
Continuous, long-term current to the coil will facilitate deterioration of coil insulation and characteristics due to heating of the coil itself. For circuits such as these, please use a magnetic-hold type latching relay. If you need to use a single stable relay, use a sealed type relay that is not easily affected by ambient conditions and make a failsafe circuit design that considers the possibility of contact failure or disconnection.

■ DC Coil operating power

Steady state DC current should be applied to the coil. The wave form should be rectangular. If it includes ripple, the ripple factor should be less than 5%.

However, please check with the actual circuit since the electrical characteristics may vary. The rated coil voltage should be applied to the coil and the set/reset pulse time of latching type relay differs for each relays, please refer to the relay's individual specifications.

■ Coil connection

When connecting coils of polarized relays, please check coil polarity (+,-) at the internal connection diagram (Schematic). If any wrong connection is made, it may cause unexpected malfunction, like abnormal heat, fire and so on, and circuit do not work. Avoid impressing voltages to the set coil and reset coil at the same time.

■ Maximum allowable voltage and temperature rise

Proper usage requires that the rated coil voltage be impressed on the coil. Note, however, that if a voltage greater than or equal to the maximum continuous voltage is impressed on the coil, the coil may burn or its layers short due to the temperature rise. Furthermore, do not exceed the usable ambient temperature range listed in the catalog.

■ Operate voltage change due to coil temperature rise

In DC relays, after continuous passage of current in the coil, if the current is turned OFF, then immediately turned ON again, due to the temperature rise in the coil, the operate voltage will become somewhat higher. Also, it will be the same as using it in a higher temperature atmosphere. The resistance/temperature relationship for copper wire is about 0.4% for 1°C, and with this ratio the coil resistance increases. That is, in order to operate of the relay, it is necessary that the voltage be higher than the operate voltage and the operate voltage rises in accordance with the increase in the resistance value. However, for some polarized relays, this rate of change is considerably smaller.

Ambient Environment

■ Usage, Transport, and Storage Conditions

During usage, storage, or transportation, avoid locations subjected to direct sunlight and maintain normal temperature, humidity and pressure conditions.

● Temperature/Humidity/Pressure

When transporting or storing relays while they are tube packaged, there are cases the temperature may differ from the allowable range. In this case be sure to check the individual specifications. Also allowable humidity level is influenced by temperature, please check charts shown below and use relays within mentioned conditions. (Allowable temperature values differ for each relays, please refer to the relay's individual specifications.)

1) Temperature:

The tolerance temperature range differs for each relays, please refer to the relay's individual specifications

2) Humidity: 5 to 85 % RH

3) Pressure: 86 to 106 kPa

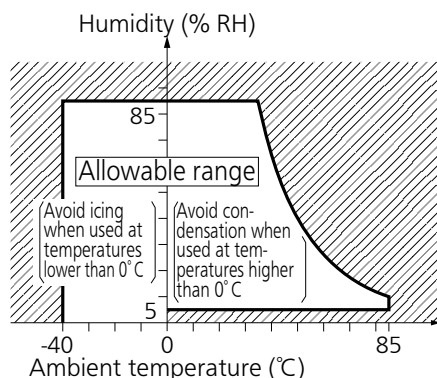

● Dew condensation

Condensation occurs when the ambient temperature drops suddenly from a high temperature and humidity, or the relay is suddenly transferred from a low ambient temperature to a high temperature and humidity. Condensation causes the failures like insulation deterioration, wire disconnection and rust etc. Panasonic Corporation does not guarantee the failures caused by condensation.

The heat conduction by the equipment may accelerate the cooling of device itself, and the condensation may occur.

Please conduct product evaluations in the worst condition of the actual usage. (Special attention should be paid when high temperature heating parts are close to the device. Also please consider the condensation may occur inside of the device.)

● Icing

Condensation or other moisture may freeze on relays when the temperature become lower than 0°C. This icing causes the sticking of movable portion, the operation delay and the contact conduction failure etc. Panasonic Corporation does not guarantee the failures caused by the icing.

The heat conduction by the equipment may accelerate the cooling of relay itself and the icing may occur. Please conduct product evaluations in the worst condition of the actual usage.

● Low temperature and low humidity

The plastic becomes brittle if the switch is exposed to a low temperature, low humidity environment for long periods of time.

● High temperature and high humidity

Storage for extended periods of time (including transportation periods) at high temperature or high humidity levels or in atmospheres with organic gases or sulfide gases may cause a sulfide film or oxide film to form on the surfaces of the contacts and/or it may interfere with the functions. Check out the atmosphere in which the units are to be stored and transported.

● Package

In terms of the packing format used, make every effort to keep the effects of moisture, organic gases and sulfide gases to the absolute minimum.

● Silicon

When a source of silicone substances (silicone rubber, silicone oil, silicone coating materials and silicone filling materials etc.) is used around the relay, the silicone gas (low molecular siloxane etc.) may be produced.

This silicone gas may penetrate into the inside of the relay. When the relay is kept and used in this condition, silicone compound may adhere to the relay contacts which may cause the contact failure.

Do not use any sources of silicone gas around the relay (Including plastic seal types).

● NOx Generation

When relay is used in an atmosphere high in humidity to switch a load which easily produces an arc, the NOx created by the arc and the water absorbed from outside the relay combine to produce nitric acid.

This corrodes the internal metal parts and adversely affects operation.

Avoid use at an ambient humidity of 85%RH or higher (at 20°C). If use at high humidity is unavoidable, please contact our sales representative.

Others

■ Cleaning

• Although the environmentally sealed type relay (plastic sealed type, etc.) can be cleaned, avoid immersing the relay into cold liquid (such as cleaning solvent) immediately after soldering. Doing so may deteriorate the sealing performance.

• Cleaning with the boiling method is recommended(The temperature of cleaning liquid should be 40°C or lower).

Avoid ultrasonic cleaning on relays. Use of ultrasonic cleaning may cause breaks in the coil or slight sticking of the contacts due to ultrasonic energy.

Please refer to **"the latest product specifications"** when designing your product.

•Requests to customers:

<https://industrial.panasonic.com/ac/e/salespolicies/>

Please contact

Panasonic Corporation

Electromechanical Control Business Division

■1006, Oaza Kadoma, Kadoma-shi, Osaka 571-8506, Japan
industrial.panasonic.com/ac/e/

Panasonic[®]

©Panasonic Corporation 2021