

## RT-3 UNIT RELAY/4-POINT TERMINAL (PhotoMOS Power type)

Slim, Space-saving, RT-3 Unit relay (Equipped with long-life PhotoMOS power type)

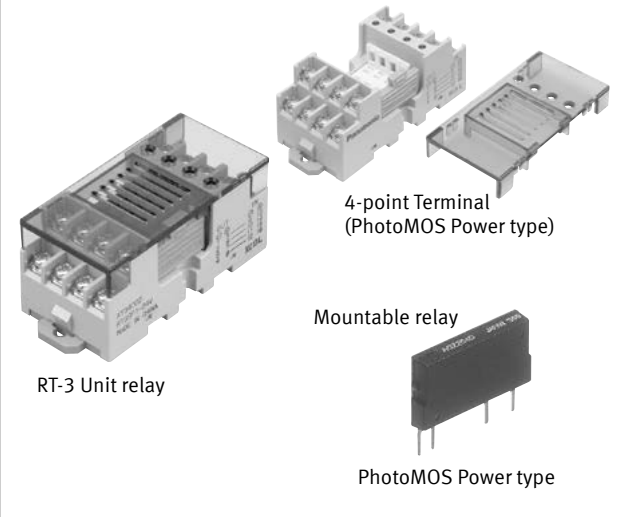

RT-3 Unit relay

4-point Terminal (PhotoMOS Power type)

Mountable relay

PhotoMOS Power type

### FEATURES

- Slim shape with width of 33 mm
- PhotoMOS Power type, for high reliability and long life, are installed.
- Can be mounted on a DIN rail or mounted directly by screw.
- Equipped with an LED display to allow easy confirmation of operation.
- Possible to select a relay for use in the 4-point terminal in accordance with its load.

### TYPES

" Type No. " is ordering part number for non Japanese market. " Part No. " is ordering part number for Japanese market.

#### RT-3 Unit relay

Contact arrangement	Type	Rated input voltage	Type No.	Part No.	Standard packing	
					Inner carton	Outer carton
1 Form A ×4	DC only (Equipped with AQZ102)	12 V DC	RT3SP1-12V	AY34001	1 pc.	20 pcs.
		24 V DC	RT3SP1-24V	AY34002		
	AC/DC dual use (Equipped with AQZ204)	12 V DC	RT3SP2-12V	AY35001		
		24 V DC	RT3SP2-24V	AY35002		

Notes: 1. Only for use with PhotoMOS Power type. Cannot be equipped with PA-N relays.  
2. Please inquire other contact arrangement.

#### 4-point Terminal

Type	Rated input voltage	Part No.	Standard packing	
			Inner carton	Outer carton
PhotoMOS Power type	12 V DC	AY30001	1 pc.	20 pcs.
	24 V DC	AY30002		

# RT-3 UNIT RELAY/4-POINT TERMINAL (PhotoMOS Power type)

## Mountable relays for 4-point Terminal

(per relay, at 25°C, initial)

Mountable relays		Output			
Type	Part No.	Max. load voltage	Recommended load voltage	Continuous load current	Peak load current
PhotoMOS Power type (DC only)	AQZ102	60 V DC	0 to 30 V DC	2.00 A	9.0 A
	AQZ105	100 V DC	0 to 50 V DC	1.50 A	6.0 A
	AQZ107	200 V DC	0 to 100 V DC	0.70 A	3.0 A
	AQZ104	400 V DC	0 to 200 V DC	0.40 A	1.5 A
PhotoMOS Power type (AC/DC dual use)	AQZ202	60 V (peak)	0 to 12 V AC/0 to 30 V DC	1.80 A	9.0 A
	AQZ205	100 V (peak)	0 to 24 V AC/0 to 50 V DC	1.20 A	6.0 A
	AQZ207	200 V (peak)	0 to 48 V AC/0 to 100 V DC	0.60 A	3.0 A
	AQZ204	400 V (peak)	0 to 125 V AC/0 to 200 V DC	0.30 A	1.5 A
	AQZ404 (1 Form B type)	400 V (peak)	0 to 125 V AC/0 to 200 V DC	0.30 A	1.5 A

- Notes: 1. Peak load current is limited to "100 ms, 1 shot".  
 2. During 4-point simultaneous operation, the rating per point is also as shown in the table above.  
 3. Please use a load current that is within the range of the data given below in "REFERENCE DATA Load current vs. ambient temperature characteristics".  
 4. Be very careful regarding the polarity on the output side when equipped with AQZ10\* (dedicated PhotoMOS power voltage sensitive DC type).  
 5. Never install relays into this product other than those given above. Doing so will cause malfunction, breakdown, and breakdown of the connected product.

## RATING

### Input rating (per relay)

Part No.	Rated input voltage	Operate voltage (at 25°C)	Release voltage (at 25°C)	Input current during application of rated input voltage (at 25°C)	Allowable variation of rated input voltage (at -20 to +55°C)
AY34001	12V DC	Max. 9.5 V DC (5.1 V typ.)	Min. 3.0 V DC (5.0 V typ)	6.2 mA typ.	90 to 110% V of rated input voltage
AY35001					
AY34002	24V DC	Max. 15.0 V DC (6.8 V typ.)	Min. 3.5 V DC (6.5 V typ.)	6.7 mA typ.	
AY35002					

Note: This product has a built-in input current limiting resistor; therefore, it is not necessary to externally connect a resistor to the input. The input voltage can be applied directly.

### Output rating (per relay, at 25°C)

Part No.	Equipped relay	Max. load voltage	Recommended voltage	Continuous load current	Peak load current
AY34001	AQZ102 (DC only)	60 V (DC)	0 to 30 V (DC)	2 A (DC)	9 A (100 ms 1 shot)
AY34002					
AY35001	AQZ204 (AC/DC dual use)	400 V (DC, AC peak value)	0 to 200 V (DC) 0 to 125 V (AC)	0.3 A (DC, AC peak value)	1.5 A (100 ms 1 shot)
AY35002					

- Notes: 1. During 4-point simultaneous operation, the rating per point is also as shown in the table above.  
 2. The load current varies depending on ambient temperature. Refer to the "REFERENCE DATA Load current vs. ambient temperature characteristics".

## SPECIFICATIONS

Item	Specifications	Conditions
Dielectric strength (initial)	Between input and output	2,000 Vrms for 1 min
	Between different terminals (between relays, both ways)	1,500 Vrms for 1 min
Insulation resistance	Min. 100 MΩ (Measured portion is the same as the case of dielectric strength.)	Using 500 V DC megger
Shock resistance	Destructive shock resistance	Min. 196 m/s <sup>2</sup> In vertical, horizontal and longitudinal directions
	Destructive vibration resistance	10 to 55 Hz at double amplitude of 1 mm In vertical, horizontal and longitudinal directions
Use condition	Ambient temperature	-20 to +55°C Avoid icing and condensation
	Ambient humidity	35 to 85% RH Avoid condensation
	Storage temperature	-30 to +80°C Avoid icing and condensation
Terminal screw fasten torque	0.3 to 0.5 N·m (3 to 5 kgf·cm)	
Cross connection protecting diode	1 A, inverse voltage 400 V	
Unit weight	Approx. 100 g	

- Notes: 1. Dielectric strength and insulation resistance are initial values.  
 2. Condensing occurs when the unit relay is exposed to sudden temperature change in a high temperature and high humidity atmosphere. This may cause some troubles like insulation failure of the socket or the PC board. Take care under this condition.  
 3. Below 0°C, condensing water can freeze and cause socket contact failures and other problems. Take care under this condition.

## REFERENCE DATA

### 1-1. Load current vs. ambient temperature characteristics

Allowable ambient temperature: -20°C to +55°C

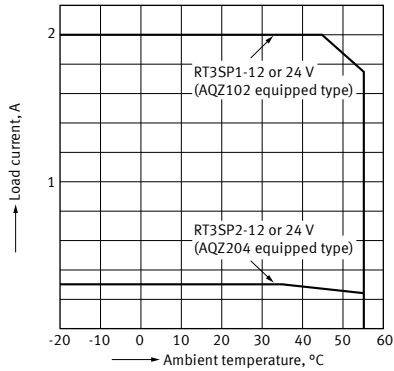

### 1-2. Load current vs. ambient temperature characteristics

Allowable ambient temperature: -20°C to +55°C

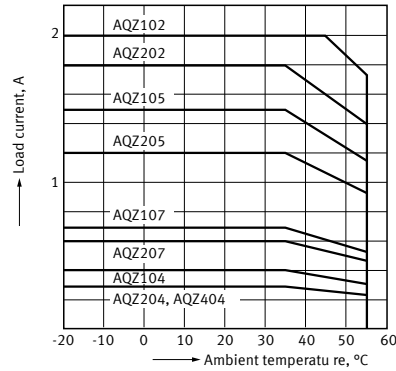

## DIMENSIONS

**CAD** The CAD data of the products with a "CAD" mark can be downloaded from our Website.

Unit: mm

### CAD

#### External dimensions

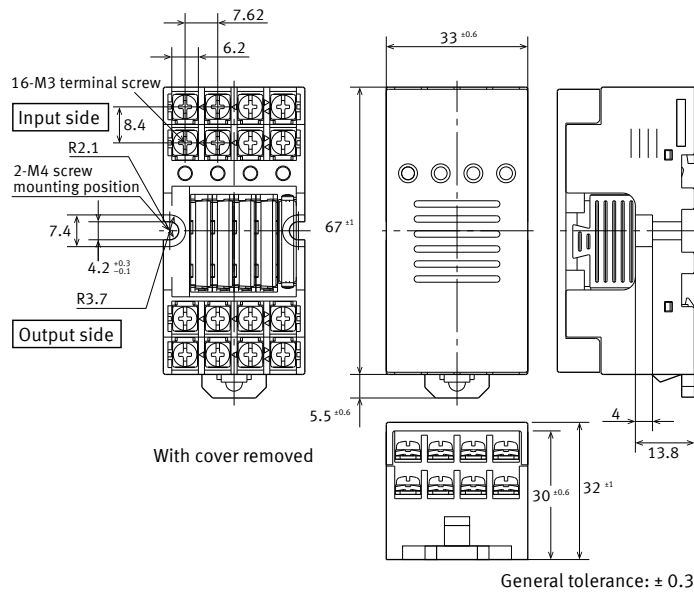

#### Schematic

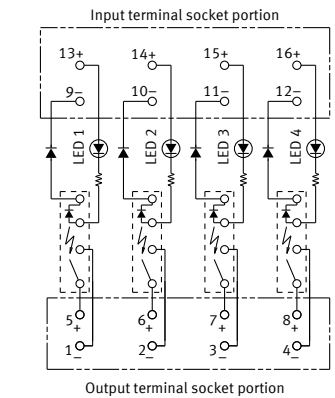

Note: The polarities of the output terminal socket are for the DC only type (equipped with AQZ 10\*)

#### Mounting hole pattern

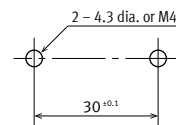

## GUIDELINES FOR USAGE

- For cautions for use, please read "GUIDELINES FOR RELAY USAGE".  
[https://industrial.panasonic.com/ac/e/control/relay/cautions\\_use/index.jsp](https://industrial.panasonic.com/ac/e/control/relay/cautions_use/index.jsp)

# CAUTIONS FOR USE RT-3 UNIT RELAY 4-POINT TERMINAL

1. Never install modules ( relays ) into this product other than those designated. Doing so will cause malfunction, breakdown, and breakdown of the connected product.
2. If a unit is dropped be sure to check its external appearance and characteristics before using it.
3. The operate and release voltage values when equipped with PA-N relays are based on the relay terminals being face down.  
( RT-3 Unit relay ( PA-N type ), 4-point Terminal )
4. Switching lifetime ( PA-N relay )  
This characteristic depends on the relay and is effected by coil driving circuit, load type, activation frequency, activation phase, ambient conditions and other factors. Also, be especially careful of loads such as those listed below.
  - 1 ) When used for AC load-operating and the operating phase is synchronous, rocking and fusing can easily occur due to contact shifting.
  - 2) Frequent switching under load condition When high frequently switched under load condition that can cause arc at the contacts, nitrogen and oxygen in the air is fused by the arc energy and  $\text{HNO}_3$  is formed. This can corrode metal materials. Three countermeasures for these are listed here.
    - ( 1 ) Incorporate an arc-extinguishing circuit.
    - ( 2 ) Lower the operating frequency
    - ( 3 ) Lower the ambient humidity
5. Operating environment
  - 1 ) Keep the product as far way as possible from power cables, high tension equipment, power equipment, equipment with transmitting devices such as amateur radios, or equipment which generates a large switching surge.
  - 2 ) The main unit is made of resin;therefore, do not use it in areas where it may come in contact with ( or be exposed to ) organic solvents such as gasoline, thinner, and alcohol, or strong alkaline substances such as ammonia and caustic soda.
  - 3 ) Do not use the product in areas where it may be exposed to flammable gases, corrosive gases, excessive dust, or moisture, or areas where it may be subjected to strong vibration or shock.

6. Installing and removing the module
  - 1 ) Firmly insert the module into the socket with the terminals going in the direction of the blade receptacles.
  - 2) The module can be easily removed using the removal key ( APA801 ). The removal key ( APA801 ) is included in 4-point Unit Relay and 4-point Terminal. If you lose it, you can purchase APA801 separately as accessories.

- ① Insert the removal key ( APA801 ) into the socket slots.

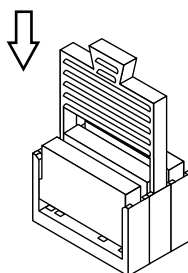

- ② Pull the removal key ( APA801 ) up to remove the module.

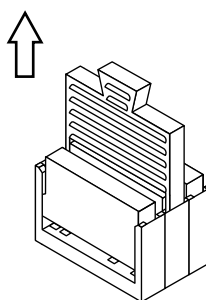

- ③ Slide the removal key ( APA801 ) off of the module.

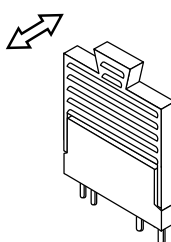

# CAUTIONS FOR USE RT-3 UNIT RELAY 4-POINT TERMINAL

## 7. Wiring and circuit configuration

- 1) Perform wiring according to the internal schematic. Take care not to make any mistakes. In particular, with the RT-3 Unit relay ( PA-N relay type ) and 4-point terminal, be careful of the polarity on the output side when equipped with AQZ10\*D ( DC type ). Also, with the RT-3 Unit relay ( PhotoMOS Power type ), be careful of the polarity on the output side of the DC type ( RT3SP1-\*V for type equipped with AQZ102 ).
- 2) We recommend the use of wirepressed terminals for connection to the terminal portion.

### ● Example of applicable wire-pressed terminal

Company Name	Part Name	Applicable wirepressed terminal
J.S.T. Mfg Co., Ltd.	1.25 to C3A	0.25 to 1.65 mm <sup>2</sup>

- 3) When the load is inductive, limit spike voltages generated from the load to less than the maximum load voltage.

Typical circuits are shown below.

- ① Add a clamp diode to the load.

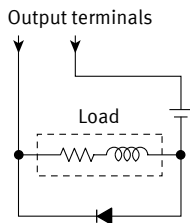

- ② Add an R-C snubber to the load.

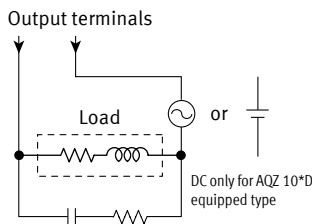

- ③ Add a varistor between the output terminals.

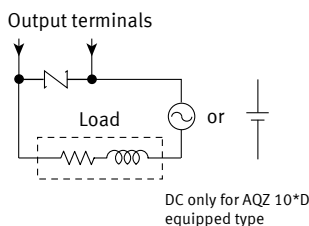

- 4) Even if spike voltages generated from the load are limited by a clamp diode or R-C snubber, inductances in long circuit wires will still create spike voltages. Keep wires as short as possible to minimize inductance.

## 8. Installation

- 1) Perform mounting hole cutout according to the panel cutout drawings.
- 2) When installing the unit on a DIN rail, use the DIN rail locking lever on the side of the unit. Installation is accomplished by simply fitting the unit onto the rail and pressing gently.

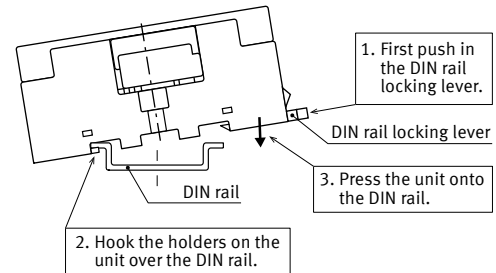

- 3) To remove the unit from the DIN rail, use a flat head screwdriver to pull out the DIN rail locking lever.

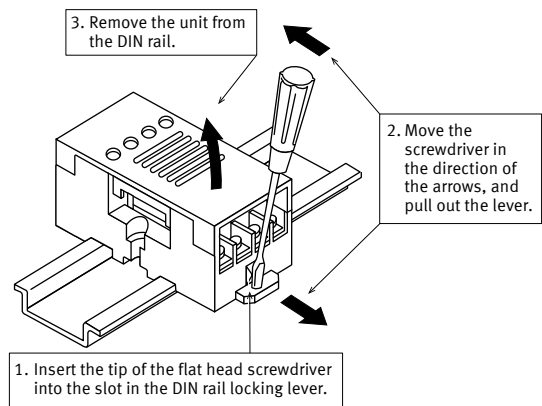

## 9. Transporting and storage

- 1) If the product is subjected to extreme vibration while being transported, the relays may become detached, the lead may become bent, and the unit may become damaged. Handle the carton and case with care.
- 2) If the product is stored in an extremely adverse environment, visible defects and deterioration of performance characteristics may result. We recommend the following storage conditions.
  - Temperature: 5 to 30 °C
  - Humidity: Max. 60 % R.H.
  - Environment: No hazardous substances such as sulfurous acid gases and little dust.

## 10. When equipped with PhotoMOS Power voltage drive type [ RT-3 Unit relay ( PA-N relay type ), 4-point Terminal ]

Since the PhotoMOS Power voltage sensitive type does not require the current-controlling resistance on the input side, it can be used together with PA-N relays on RT-3 unit relay ( PA-N relay type ). When connecting PhotoMOS Power voltage sensitive types, since it will be a close connection, it will be necessary to be careful of load currents. Be sure to refer to the information given regarding "Load currents vs ambient temperature characteristics" in the precautions given for use of 4-point terminals.

# CAUTIONS FOR USE RT-3 UNIT RELAY 4-POINT TERMINAL

## TERMINAL BLOCK

We recommend using wire-pressed terminals for connection to the terminal portion.

- **Applicable electrical wire**

0.25 to 1.65 mm<sup>2</sup>

- **Applicable wire-pressed terminals ( mm )**

Company Name	Part Name	Part Name
J.S.T. Mfg Co., Ltd.	1.25 to C3A	1.25 to 3
NICHIFU	1.25Y to 3N	1.25 to 3
Nippon Tanshi Co., Ltd.	VD1.25 to 3L	R1.25 to 3

## ACCESSORIES

- **Short circuit plate for RT-3 Unit relay**

Use when you want to bridge terminals.

< With insulator >



AY3802

External dimensions ( mm )

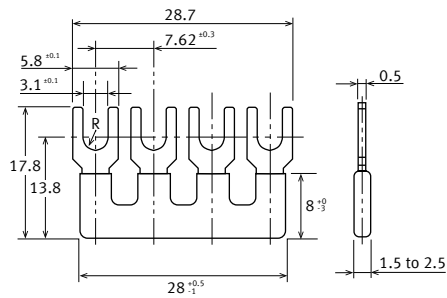

General tolerance: ± 0.5

< Without insulator >



AY3803

External dimensions ( mm )

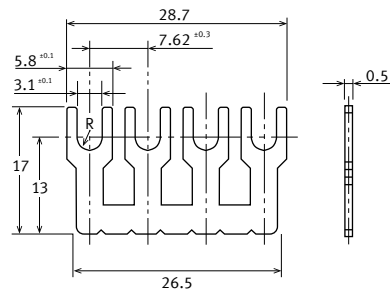

General tolerance: ±0.5

---

Please contact .....

**Panasonic Corporation**

Electromechanical Control Business Division

■1006, Oaza Kadoma, Kadoma-shi, Osaka 571-8506, Japan  
[industrial.panasonic.com/ac/e/](http://industrial.panasonic.com/ac/e/)

**Panasonic**<sup>®</sup>

©Panasonic Corporation 2021