

LQ RELAYS

1 Form A/1 Form C, 10A Small power relays

[Protective construction] Sealed

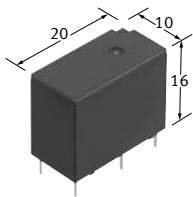

(Unit : mm)

FEATURES

- **Small and slim:** 10 mm (W) × 20mm (L) × 16mm (H)
- **Compact with high capacity:**
1 Form A / 1 Form C, 10 A
- **Class “F” coil is available.**
- **Contact rating at 105°C is approved by UL/C-UL (Class “F” coil only)**
Please refer to “SAFETY STANDARDS” about the detail of contact rating.
- **Surge withstand voltage (Between contact and coil) : 8,000 V**
- **High Dielectric strength voltage (Between contact and coil) : 4,000 Vrms**

TYPICAL APPLICATIONS

- Home appliance
- Industrial equipment

ORDERING INFORMATION (PART NO.)

ALQ

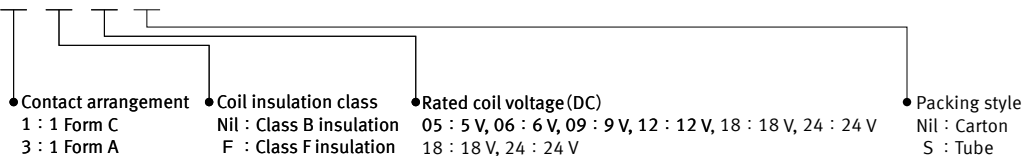

Note : 1. The “S” at the end of the part number only appears on the inner and outer packing. It does not appear on the relay itself.
2. 48V DC types is also available. Please contact our sales representative for details.

TYPES

- PC board terminal
- Carton

Contact arrangement	Rated coil volatage	Part No. *		Standard packing	
		Class B insulation	Class F insulation	Inner carton	Outer carton
1 Form A	5 V DC	ALQ305	ALQ3F05	Carton: 100 pcs Tube: 50 pcs	Carton: 500 pcs Tube: 1,000 pcs
	6 V DC	ALQ306	ALQ3F06		
	9 V DC	ALQ309	ALQ3F09		
	12 V DC	ALQ312	ALQ3F12		
	18 V DC	ALQ318	ALQ3F18		
	24 V DC	ALQ324	ALQ3F24		
1 Form C	5 V DC	ALQ105	ALQ1F05	Carton: 100 pcs Tube: 50 pcs	Carton: 500 pcs Tube: 1,000 pcs
	6 V DC	ALQ106	ALQ1F06		
	9 V DC	ALQ109	ALQ1F09		
	12 V DC	ALQ112	ALQ1F12		
	18 V DC	ALQ118	ALQ1F18		
	24 V DC	ALQ124	ALQ1F24		

* Tube packing types available. When ordering, please add suffix “S”.

Power Relays (Over 2A) LQ RELAYS

RATING

Coil data

- Operating characteristics such as 'Operate voltage' and 'Release voltage' are influenced by mounting conditions, ambient temperature, etc. Therefore, please use the relay within $\pm 5\%$ of rated coil voltage.
- 'Initial' means the condition of products at the time of delivery.

Contact arrangement	Rated coil voltage	Operate voltage* ¹ (at 20°C)	Release voltage* ¹ (at 20°C)	Rated operating current ($\pm 10\%$, at 20°C)	Coil resistance ($\pm 10\%$, at 20°C)	Rated operating power	Max. allowable voltage
1 Form A	5 V DC	Max. 75% V of rated coil voltage (initial)	Min. 5% V of rated coil voltage (initial)	40 mA	125 Ω	200 mW	130% of rated coil voltage (at 85°C)* ² 180% of rated coil voltage (at 20°C)
	6 V DC			33.3 mA	180 Ω		
	9 V DC			22.2 mA	405 Ω		
	12 V DC			16.7 mA	720 Ω		
	18 V DC			11.1 mA	1,620 Ω		
	24 V DC			8.3 mA	2,880 Ω		
1 Form C	5 V DC	Max. 75% V of rated coil voltage (initial)	Min. 5% V of rated coil voltage (initial)	80 mA	62.5 Ω	400 mW	110% of rated coil voltage (at 85°C)* ² 150% of rated coil voltage (at 20°C)
	6 V DC			66.7 mA	90 Ω		
	9 V DC			44.4 mA	202.5 Ω		
	12 V DC			33.3 mA	360 Ω		
	18 V DC			22.2 mA	810 Ω		
	24 V DC			16.7 mA	1,440 Ω		

*1. Square, pulse drive

*2. When using relays in a high ambient temperature, consider the operate voltage rise due to the high temperature (a rise of approx. 0.4% V for each 1°C with 20°C as a reference) and use a coil impressed voltage that is within the maximum applied voltage range.

■ Specifications

Item		Specifications	
Contact data	Contact arrangement	1 Form A	1 Form C
	Contact resistance (initial)	Max. 100 mΩ (by voltage drop 6 V DC 1 A)	
	Contact material	AgNi type	
	Contact rating (resistive)	5 A 30 V DC, 10 A 125 V AC, 5 A 250 V AC	Form A contact: 10 A 125 V AC, 5 A 250 V AC, 5 A 30 V DC Form B contact: 3 A 125 V AC, 2 A 250 V AC, 1 A 30 V DC
	Max. switching power (resistive)	1,250 VA, 150 W	Form A contact: 1,250 VA, 150 W Form B contact: 500 VA, 30 W
	Max. switching voltage	250 V AC, 30 V DC	
	Max. switching current	10 A (125 V AC), 5 A (30 V DC)	Form A contact: 10 A (125 V AC), 5 A (30 V DC) Form B contact: 3 A (125 V AC), 1 A (30 V DC)
	Min. switching load (reference value)*1	100 mA 5 V DC	
Insulation resistance (initial)	Min. 1,000 MΩ (at 500 V DC, Measured portion is the same as the case of dielectric strength)		
Dielectric strength (initial)	Between open contacts	1,000 Vrms for 1 min (detection current: 10 mA)	750 Vrms for 1 min (detection current: 10 mA)
	Between contact and coil	4,000 Vrms for 1 min (detection current: 10 mA)	
Surge withstand voltage (initial)*2	Between contact and coil	8,000 V	
Time characteristics (initial)	Operate time	Max. 20 ms (at rated coil voltage, at 20°C, without bounce)	
	Release time	Max. 20 ms (at rated coil voltage, at 20°C, without bounce, with diode)	
Shock resistance	Functional	294 m/s ² (half-sine shock pulse: 11 ms, detection time: 10 μs)	196 m/s ² (half-sine shock pulse: 11 ms, detection time: 10 μs)
	Destructive	980 m/s ² (half-sine shock pulse: 6 ms)	
Vibration resistance	Functional	10 to 55 Hz (at double amplitude of 1.6 mm, detection time: 10 μs)	
	Destructive	10 to 55 Hz (at double amplitude of 2 mm)	
Expected life	Mechanical life	Min. 10 × 10 ⁵ (at 180 times/min)	
Conditions	Conditions for usage, transport and storage*3	Ambient temperature: -40 to +85°C*4 Humidity: 5 to 85% RH (Avoid icing and condensation)	
Unit weight	Approx. 7 g		

Note: Specifications will vary with foreign standards certification ratings.

*1. This value can change due to the switching frequency, environmental conditions, and desired reliability level, therefore it is recommended to check this with the actual load.

*2. Wave is standard shock voltage of ±1.2×50μs according to JEC-212-1981

*3. For ambient temperature, please read "GUIDELINES FOR RELAY USAGE".

*4. When using relays in a high ambient temperature, consider the operate voltage rise due to the high temperature (a rise of approx. 0.4% V for each 1°C with 20°C as a reference) and use a coil impressed voltage that is within the maximum applied voltage range.

Power Relays (Over 2A) LQ RELAYS

Expected electrical life

Condition: Resistive load, at 20°C, at 20 times/min, with diode

Type		Switching capacity	Number of operations
1 Form A		5 A 30 V DC	100×10^3
		10 A 125 V AC	50×10^3
		5 A 250 V AC	50×10^3
1 Form C		5 A 30 V DC	100×10^3
		10 A 125 V AC	50×10^3
		5 A 250 V AC	50×10^3
		3 A 125 V AC	200×10^3
		2 A 250 V AC	200×10^3
		1 A 30 V DC	100×10^3

REFERENCE DATA

1-1. Max. switching capacity (1 Form A)

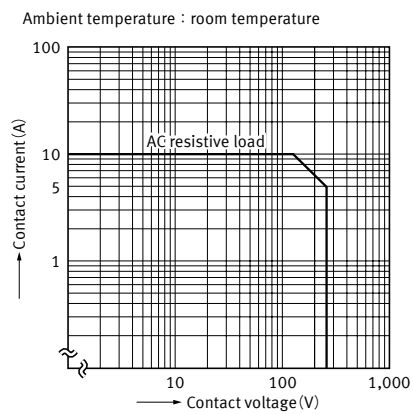

1-2. Max. switching capacity (1 Form C)

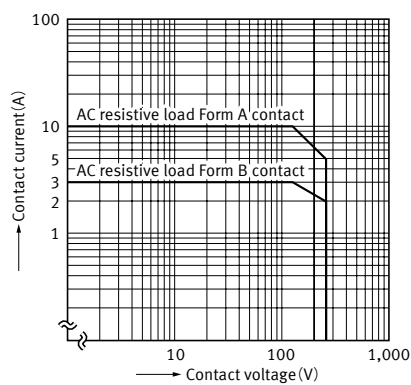

2. Switching life curve (Form A contact)

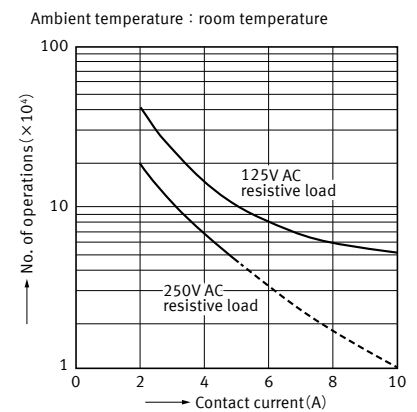

3-1. Coil temperature characteristics (1 Form A)

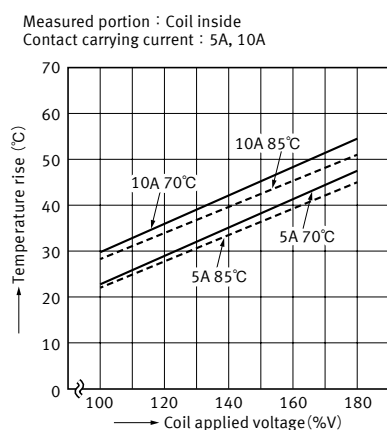

3-2. Coil temperature characteristics (1 Form C)

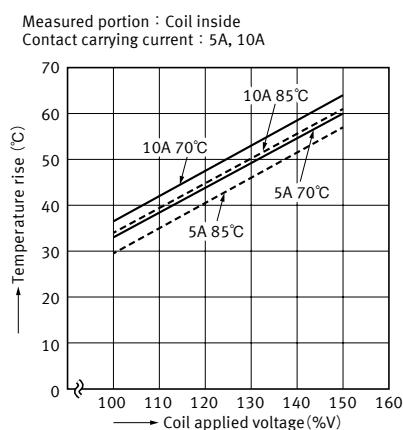

4-1. Ambient temperature characteristics
(1 Form A)

Contact carrying current : 5A, 10A

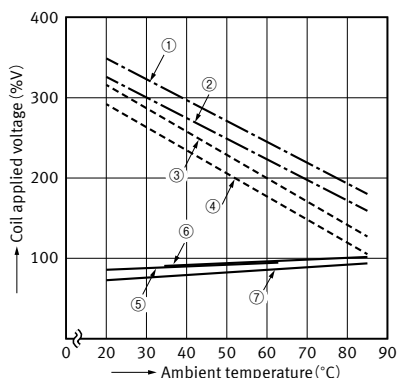

4-2. Ambient temperature characteristics
(1 Form C)

Measured portion : Coil inside
Contact carrying current : 5A, 10A

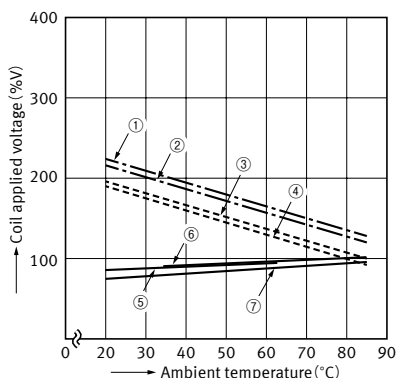

- ① Allowable ambient temperature against % coil voltage (max. inside the coil temperature set as 130°C) (Carrying current : 5 A)
- ② Allowable ambient temperature against % coil voltage (max. inside the coil temperature set as 130°C) (Carrying current : 10 A)
- ③ Allowable ambient temperature against % coil voltage (max. inside the coil temperature set as 115°C) (Carrying current : 5 A)
- ④ Allowable ambient temperature against % coil voltage (max. inside the coil temperature set as 115°C) (Carrying current : 10 A)
- ⑤ Operate voltage with a hot-start condition of 100%V on the coil (Carrying current : 10 A)
- ⑥ Operate voltage with a hot-start condition of 100%V on the coil (Carrying current : 5 A)
- ⑦ Operate voltage

DIMENSIONS

CAD The CAD data of the products with a "CAD" mark can be downloaded from our Website.

Unit: mm

■ 1 Form A

CAD

External dimensions

Recommended
PC board pattern
(BOTTOM VIEW)

Schematic
(BOTTOM VIEW)

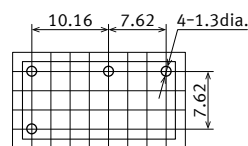
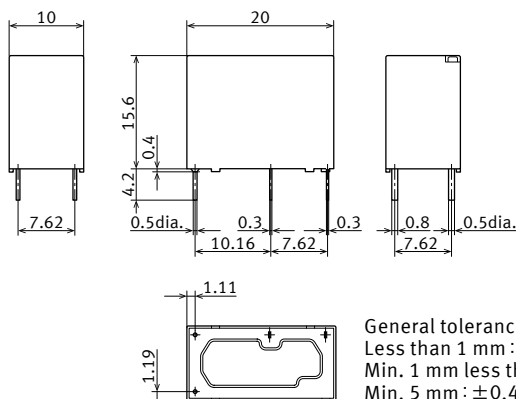

Tolerance ±0.1



General tolerance
Less than 1 mm : ±0.2
Min. 1 mm less than 5 mm : ±0.3
Min. 5 mm : ±0.4

■ 1 Form C

CAD

External dimensions

Recommended
PC board pattern
(BOTTOM VIEW)

Schematic
(BOTTOM VIEW)

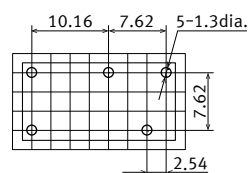
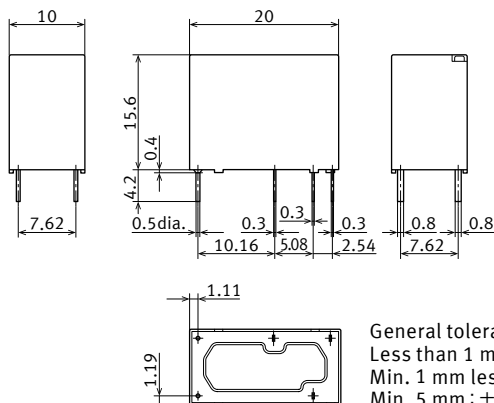

Tolerance ±0.1



General tolerance
Less than 1 mm : ±0.2
Min. 1 mm less than 5 mm : ±0.3
Min. 5 mm : ±0.4

Power Relays (Over 2A) LQ RELAYS

SAFETY STANDARDS

Each standard may be updated at any time, so please check our Website for the latest information.

UL/C-UL (Recognized)

1 Form A (ALQ 3**)

File No.	Contact rating	Operations	Ambient temperature
E43028	10 A 125 V AC General use	50 × 10 ³	40°C
	10 A 125 V AC Carry Only	50 × 10 ³	85°C
	5 A 277 V AC General use	100 × 10 ³	40°C
	5 A 240 V AC General use	6 × 10 ³	105°C
	5 A 30 V DC General use	100 × 10 ³	40°C
	4 A 125 V AC Resistive	100 × 10 ³	105°C
	2 A 120 V AC Tungsten	6 × 10 ³	105°C
	4 FLA/4 LRA 277 V AC	100 × 10 ³	105°C
	1/6 HP 277 V AC	10 ³	40°C
	1/6 HP 125 V AC	10 ³	40°C
	Pilot Duty 1 A 125 V AC*	100 × 10 ³	105°C

* Pilot Duty comply with UL508 testing conditions.

CSA (Certified)

CSA standard certified by C-UL

VDE (Certified)

1 Form A (ALQ 3**)

File No.	Contact rating	Operations	Ambient temperature
40032836	10 A 250 V AC (cosφ = 1.0)	10 × 10 ³	85°C
	10 A 250 V AC (cosφ = 0.4)	10 × 10 ³	85°C
	5 A 250 V AC (cosφ = 1.0)	50 × 10 ³	85°C
	5 A 30 V DC (0 ms)	10 × 10 ³	85°C

CQC (Certified)

1 Form A (ALQ 3**)

File No.	Contact rating
CQC14002108384	5 A 250 V AC

1 Form C (ALQ 1**)

File No.	Contact	Contact rating	Operations	Ambient temperature
E43028	Form A contact	10 A 125 V AC General use	50 × 10 ³	40°C
		5 A 277 V AC General use	100 × 10 ³	40°C
		5 A 240 V AC Resistive	100 × 10 ³	80°C
		5 A 30 V DC General use	100 × 10 ³	40°C
		4 FLA/4 LRA 277 V AC	100 × 10 ³	105°C
		3 FLA/18 LRA 240 V AC	100 × 10 ³	85°C
		1/6 HP 277 V AC	10 ³	40°C
		1/6 HP 125 V AC	10 ³	40°C
	Form B contact	3 A 240 V AC Resistive	100 × 10 ³	80°C
		3 A 125 V AC General use	100 × 10 ³	85°C
		2 A 277 V AC General use	100 × 10 ³	85°C
		2 A 30 V DC Resistive	100 × 10 ³	40°C
		1 A 30 V DC General use	100 × 10 ³	85°C

1 Form C (ALQ 1**)

File No.	Contact	Contact rating	Operations	Ambient temperature
40032836	Form A contact	10 A 250 V AC (cosφ = 1.0)	10 × 10 ³	85°C
		10 A 250 V AC (cosφ = 0.4)	10 × 10 ³	85°C
		5 A 250 V AC (cosφ = 1.0)	50 × 10 ³	85°C
		5 A 30 V DC (0 ms)	10 × 10 ³	85°C
	Form B contact	3 A 250 V AC (cosφ = 0.4)	10 × 10 ³	85°C

1 Form C (ALQ 1**)

File No.	Contact	Contact rating
CQC14002108384	Form A contact	5 A 250 V AC
	Form B contact	2 A 250 V AC

INSULATION CHARACTERISTICS (IEC61810-1)

Item	Characteristic
Clearance/Creepage distance (IEC61810-1)	Min. 4.0/4.0 mm (Form A contact)
Category of protection (IEC61810-1)	RTIII
Tracking resistance (IEC60112)	PTI 175
Insulation material group	III a
Over voltage category	III
Rated voltage	250 V
Pollution degree	2
Type of insulation (Between contact and coil)	Basic insulation
Type of insulation (Between open contacts)	Micro disconnection

Note) Actual value.

GUIDELINES FOR USAGE

For cautions for use, please read "GUIDELINES FOR RELAY USAGE".

https://industrial.panasonic.com/ac/e/control/relay/cautions_use/index.jsp

GUIDELINES FOR POWER, HIGH-CAPACITY DC CUT OFF AND SAFETY RELAYS USAGE

■ For cautions for use, please read “GUIDELINES FOR RELAY USAGE”.
https://industrial.panasonic.com/ac/e/control/relay/cautions_use/index.jsp

Precautions for Coil Input

■ Long term current carrying

A circuit that will be carrying a current continuously for long periods without relay switching operation. (circuits for emergency lamps, alarm devices and error inspection that, for example, revert only during malfunction and output warnings with form B contacts)
Continuous, long-term current to the coil will facilitate deterioration of coil insulation and characteristics due to heating of the coil itself. For circuits such as these, please use a magnetic-hold type latching relay. If you need to use a single stable relay, use a sealed type relay that is not easily affected by ambient conditions and make a failsafe circuit design that considers the possibility of contact failure or disconnection.

■ DC Coil operating power

Steady state DC current should be applied to the coil. The wave form should be rectangular. If it includes ripple, the ripple factor should be less than 5%.

However, please check with the actual circuit since the electrical characteristics may vary. The rated coil voltage should be applied to the coil and the set/reset pulse time of latching type relay differs for each relays, please refer to the relay's individual specifications.

■ Coil connection

When connecting coils of polarized relays, please check coil polarity (+,-) at the internal connection diagram (Schematic). If any wrong connection is made, it may cause unexpected malfunction, like abnormal heat, fire and so on, and circuit do not work. Avoid impressing voltages to the set coil and reset coil at the same time.

■ Maximum allowable voltage and temperature rise

Proper usage requires that the rated coil voltage be impressed on the coil. Note, however, that if a voltage greater than or equal to the maximum continuous voltage is impressed on the coil, the coil may burn or its layers short due to the temperature rise. Furthermore, do not exceed the usable ambient temperature range listed in the catalog.

■ Operate voltage change due to coil temperature rise

In DC relays, after continuous passage of current in the coil, if the current is turned OFF, then immediately turned ON again, due to the temperature rise in the coil, the operate voltage will become somewhat higher. Also, it will be the same as using it in a higher temperature atmosphere. The resistance/temperature relationship for copper wire is about 0.4% for 1°C, and with this ratio the coil resistance increases. That is, in order to operate of the relay, it is necessary that the voltage be higher than the operate voltage and the operate voltage rises in accordance with the increase in the resistance value. However, for some polarized relays, this rate of change is considerably smaller.

Ambient Environment

■ Usage, Transport, and Storage Conditions

During usage, storage, or transportation, avoid locations subjected to direct sunlight and maintain normal temperature, humidity and pressure conditions.

● Temperature/Humidity/Pressure

When transporting or storing relays while they are tube packaged, there are cases the temperature may differ from the allowable range. In this case be sure to check the individual specifications. Also allowable humidity level is influenced by temperature, please check charts shown below and use relays within mentioned conditions. (Allowable temperature values differ for each relays, please refer to the relay's individual specifications.)

1) Temperature:

The tolerance temperature range differs for each relays, please refer to the relay's individual specifications

2) Humidity: 5 to 85 % RH

3) Pressure: 86 to 106 kPa

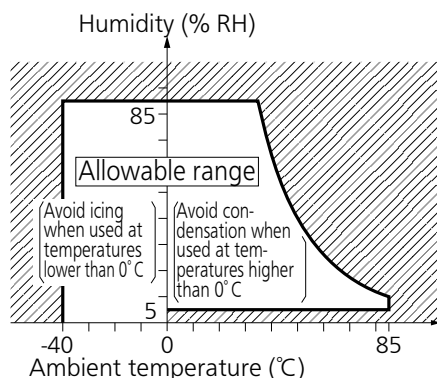

● Dew condensation

Condensation occurs when the ambient temperature drops suddenly from a high temperature and humidity, or the relay is suddenly transferred from a low ambient temperature to a high temperature and humidity. Condensation causes the failures like insulation deterioration, wire disconnection and rust etc. Panasonic Corporation does not guarantee the failures caused by condensation.

The heat conduction by the equipment may accelerate the cooling of device itself, and the condensation may occur.

Please conduct product evaluations in the worst condition of the actual usage. (Special attention should be paid when high temperature heating parts are close to the device. Also please consider the condensation may occur inside of the device.)

● Icing

Condensation or other moisture may freeze on relays when the temperature become lower than 0°C. This icing causes the sticking of movable portion, the operation delay and the contact conduction failure etc. Panasonic Corporation does not guarantee the failures caused by the icing.

The heat conduction by the equipment may accelerate the cooling of relay itself and the icing may occur. Please conduct product evaluations in the worst condition of the actual usage.

● Low temperature and low humidity

The plastic becomes brittle if the switch is exposed to a low temperature, low humidity environment for long periods of time.

● High temperature and high humidity

Storage for extended periods of time (including transportation periods) at high temperature or high humidity levels or in atmospheres with organic gases or sulfide gases may cause a sulfide film or oxide film to form on the surfaces of the contacts and/or it may interfere with the functions. Check out the atmosphere in which the units are to be stored and transported.

● Package

In terms of the packing format used, make every effort to keep the effects of moisture, organic gases and sulfide gases to the absolute minimum.

● Silicon

When a source of silicone substances (silicone rubber, silicone oil, silicone coating materials and silicone filling materials etc.) is used around the relay, the silicone gas (low molecular siloxane etc.) may be produced.

This silicone gas may penetrate into the inside of the relay. When the relay is kept and used in this condition, silicone compound may adhere to the relay contacts which may cause the contact failure.

Do not use any sources of silicone gas around the relay (Including plastic seal types).

● NOx Generation

When relay is used in an atmosphere high in humidity to switch a load which easily produces an arc, the NOx created by the arc and the water absorbed from outside the relay combine to produce nitric acid.

This corrodes the internal metal parts and adversely affects operation.

Avoid use at an ambient humidity of 85%RH or higher (at 20°C). If use at high humidity is unavoidable, please contact our sales representative.

Others

■ Cleaning

• Although the environmentally sealed type relay (plastic sealed type, etc.) can be cleaned, avoid immersing the relay into cold liquid (such as cleaning solvent) immediately after soldering. Doing so may deteriorate the sealing performance.

• Cleaning with the boiling method is recommended(The temperature of cleaning liquid should be 40°C or lower).

Avoid ultrasonic cleaning on relays. Use of ultrasonic cleaning may cause breaks in the coil or slight sticking of the contacts due to ultrasonic energy.

Please refer to **"the latest product specifications"** when designing your product.

•Requests to customers:

<https://industrial.panasonic.com/ac/e/salespolicies/>

Please contact

Panasonic Corporation

Electromechanical Control Business Division

■1006, Oaza Kadoma, Kadoma-shi, Osaka 571-8506, Japan
industrial.panasonic.com/ac/e/

Panasonic[®]

©Panasonic Corporation 2021