

HE RELAYS PV Type

Compact size, 1 Form A 35 A/48 A/90 A Power relays for solar inverter

Protective construction : Flux-resistant type

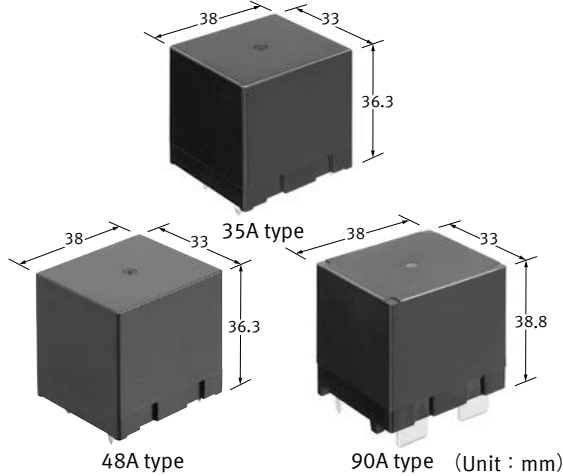

FEATURES

- High capacity and compact size
35 A/48 A type: W (38 mm) × L (33 mm) × H (36.3 mm)
90 A type: W (38 mm) × L (33 mm) × H (38.8 mm)
- Contact GAP (compliant with VDE0126)
- Contributes to energy saving in devices thanks to reduced coil hold voltage
- High insulation: 10,000 V surge withstand voltage (between contact and coil)
- Conforms to various safety standards: UL/C-UL, CSA, VDE

TYPICAL APPLICATIONS

- Inverter (Solar and industrial)
- UPS
- Stationary charging stand

DETAILS FEATURES

■ Compact size

Due to improved conduction efficiency, wide terminal blades are used (for 48 A and 90 A type)

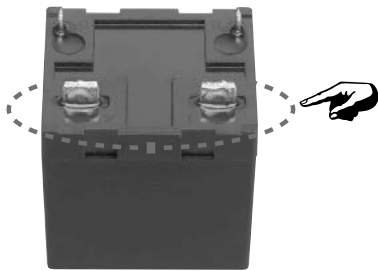

Note: 48 A type

■ Contact GAP

Compliant with European photovoltaic standard (VDE0126)
Compliant with EN61810-1 2.5k V surge withstand voltage (between contacts)

Type	Contact GAP
35 A/48 A	2.5 mm
90 A	3 mm

■ Coil hold voltage* reduction can reduce consumption power.

Coil hold voltage can be reduced down 40% of the rated coil voltage. This is equal to operating power of approximately 310 mW.

*Coil hold voltage is the coil voltage after 100ms following application of the rated coil voltage.

Power relays (Over 2 A) HE RELAYS PV Type

ORDERING INFORMATION (PART NO. : Ordering part number for Japanese market)

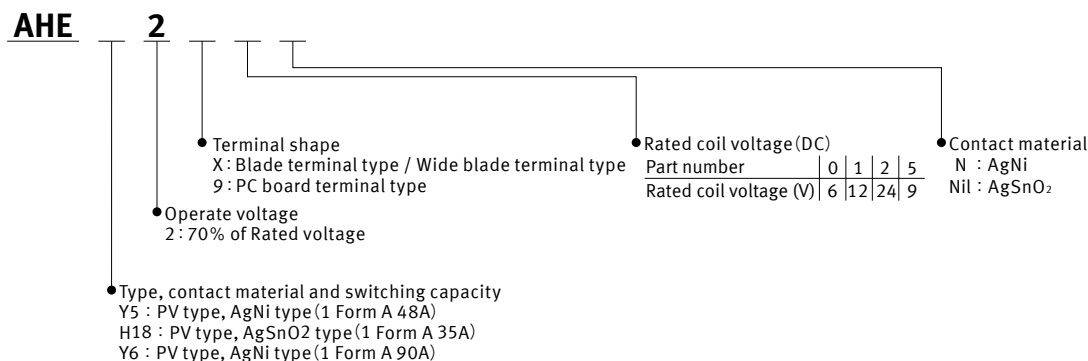

ORDERING INFORMATION (TYPE NO. : Ordering part number for non Japanese market)

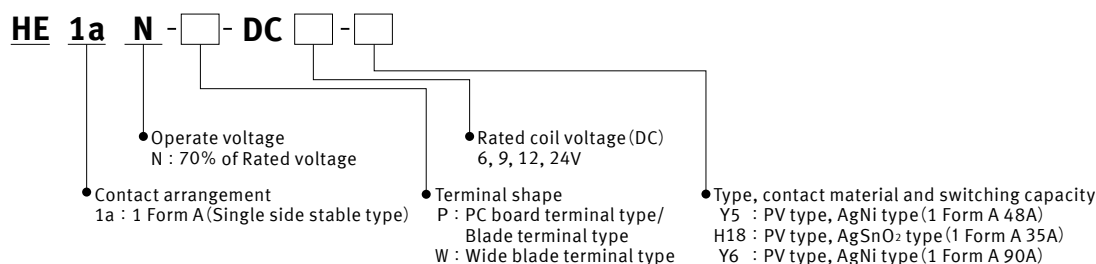

TYPES

" Type No. " is ordering part number for non Japanese market. " Part No. " is ordering part number for Japanese market.

Type	Rated coil voltage	Type No.	Part No.	Standard packing	
				Inner carton	Outer carton
35 A	6 V DC	HE1aN-P-DC6V-H18	AHE4290	25 pcs.	100 pcs.
	9 V DC	HE1aN-P-DC9V-H18	AHE4295		
	12 V DC	HE1aN-P-DC12V-H18	AHE4291		
	24 V DC	HE1aN-P-DC24V-H18	AHE4292		
48 A	6 V DC	HE1aN-P-DC6V-Y5	AHE32X0N		
	9 V DC	HE1aN-P-DC9V-Y5	AHE32X5N		
	12 V DC	HE1aN-P-DC12V-Y5	AHE32X1N		
	24 V DC	HE1aN-P-DC24V-Y5	AHE32X2N		
90 A	6 V DC	HE1aN-W-DC6V-Y6	AHE52X0N		
	9 V DC	HE1aN-W-DC9V-Y6	AHE52X5N		
	12 V DC	HE1aN-W-DC12V-Y6	AHE52X1N		
	24 V DC	HE1aN-W-DC24V-Y6	AHE52X2N		

*35 A 6 V, 12 V and 24 V DC type: Certified by UL/C-UL (35 A 9 V type: Certified by UL/C-UL and VDE)

RATING

Coil data

- Operating characteristics such as 'Operate voltage' and 'Release voltage' are influenced by mounting conditions, ambient temperature, etc.

Therefore, please use the relay within $\pm 5\%$ of rated coil voltage.

- 'Initial' means the condition of products at the time of delivery.

Rated coil voltage	Operate voltage* (at 20°C)	Release voltage* (at 20°C)	Rated operating current ($\pm 10\%$, at 20°C)	Coil resistance ($\pm 10\%$, at 20°C)	Rated operating power	Max. allowable voltage (at 20°C)
6 V DC	Max. 70% V of rated coil voltage (Initial)	Min. 10% V of rated coil voltage (Initial)	320 mA	18.8 Ω	1,920 mW	110% V of rated coil voltage
9 V DC			213 mA	42.2 Ω		
12 V DC			160 mA	75 Ω		
24 V DC			80 mA	300 Ω		

*square, pulse drive

Specifications

Item		Specifications		
		35 A type	48 A type	90 A type
Contact data	Contact arrangement	1 Form A		
	Contact resistance (initial)	Max. 100 mΩ (by voltage drop 6 V DC 1 A)		Max. 10 mΩ (by voltage drop 5 V DC 20 A)
	Contact material	AgSnO ₂ type	AgNi type	
	Contact rating (resistive)	35 A 490 V AC, 35 A 48 V DC	48 A 490 V AC, 48 A 48 V DC	60 A 490 V AC, 90 A 60 V DC
	Max. switching power (resistive)	17,150 VA, 1,680 W	23,520 VA, 2,304 W	29,400 VA, 5,400 W
	Max. switching voltage	490 V AC, 48 V DC		490 V AC, 60 V DC
	Max. switching current	35 A	48 A	90 A
	Min. switching load (reference value) *1	100 mA 5 V DC		
Insulation resistance (initial)		Min. 1,000 MΩ (at 500 V DC, Measured portion is the same as the case of dielectric strength.)		
Dielectric strength (initial)	Between open contacts	2,000 Vrms for 1 min (detection current: 10 mA)		
	Between contact and coil	5,000 Vrms for 1 min (detection current: 10 mA)		
Surge withstand voltage (initial)*2	Between contact and coil	10,000 V		
Coil holding voltage*2		40 to 100% V (at -50 to 55°C) 50 to 60% V (at 55 to 85°C)		
Time characteristics (initial)	Operate time	Max. 30 ms at rated coil voltage (at 20°C, without bounce)		
	Release time*5	Max. 10 ms at rated coil voltage (at 20°C, without bounce, without diode)		
Shock resistance	Functional	98 m/s ² (half-sine shock pulse: 11 ms, detection time: 10 μs)		
	Destructive	980 m/s ² (half-sine shock pulse: 6 ms)		
Vibration resistance	Functional	10 to 55 Hz (at double amplitude of 1 mm, detection time: 10 μs)		
	Destructive	10 to 55 Hz (at double amplitude of 1.5 mm)		
Expected life	Mechanical life	Min. 10 x 10 ⁶ ope. (switching frequency: 180 times/min)	Min. 10 ⁸ ope. (switching frequency: 180 times/min)	
Conditions	Conditions for usage, transport and storage*4	Ambient temperature: -50 to +85°C (When using at 55°C or higher, the coil holding voltage should be 50% V to 60% V) Humidity: 5 to 85% RH (Avoid icing and condensation)		
Unit weight		Approx. 80 g		Approx. 85 g

*1. This value can change due to the switching frequency, environmental conditions, and desired reliability level, therefore it is recommended to check this with the actual load.

*2. Wave is standard shock voltage of $\pm 1.2 \times 50 \mu s$ according to JEC-212-1981

*3. Coil holding voltage is the coil voltage after 100 ms from the applied rated voltage.

*4. For ambient temperature, please read "GUIDELINES FOR RELAY USAGE".

*5. Release time will lengthen if a diode, etc., is connected in parallel to the coil. Be sure to verify operation under actual conditions.

Expected electrical life

Type	Load	Switching capacity	Number of operations	
1 Form A	35 A	Resistive load	30 A 250 V AC	Min. 200 x 10 ³ ope. (room temperature, switching frequency 20 times/min)
			35 A 277 V AC	Min. 30 x 10 ³ ope. (at 85°C, switching frequency ON : OFF = 1 s : 9 s)
			35 A 490 V AC	Min. 10 x 10 ³ ope. (room temperature, switching frequency ON : OFF = 1 s : 9 s)
			35 A 48 V DC	Min. 10 x 10 ³ ope. (room temperature, switching frequency ON : OFF = 1 s : 9 s)
	48 A	Resistive load	48 A 277 V AC	Min. 30 x 10 ³ ope. (at 85°C, switching frequency ON : OFF = 1 s : 9 s)
			48 A 490 V AC	Min. 10 x 10 ³ ope. (room temperature, switching frequency ON : OFF = 1 s : 9 s)
			48 A 30 V DC	Min. 30 x 10 ³ ope. (at 85°C, switching frequency ON : OFF = 1 s : 9 s)
			48 A 48 V DC	Min. 10 x 10 ³ ope. (room temperature, switching frequency ON : OFF = 1 s : 9 s)
	Inductive load		48 A 250 V AC (cos Φ = 0.8)	Min. 30 x 10 ³ ope. (at 85°C, switching frequency ON : OFF = 0.1 s : 10 s)
			72 A 250 V AC (cos Φ = 0.8)	Min. 50 ope. (at 85°C, switching frequency ON : OFF = 0.1 s : 10 s)
	90 A	Resistive load	60 A 277 V AC	Min. 10 x 10 ³ ope. (at 85°C, switching frequency ON : OFF = 1 s : 9 s)
			60 A 490 V AC	Min. 10 x 10 ³ ope. (room temperature, switching frequency ON : OFF = 1 s : 9 s)
			80 A 277 V AC	Min. 10 x 10 ³ ope. (room temperature, switching frequency ON : OFF = 1 s : 9 s)
			90 A 277 V AC	Min. 10 ³ ope. (at 85°C, switching frequency ON : OFF = 1 s : 9 s)
80 A 48 V DC			Min. 10 x 10 ³ ope. (room temperature, switching frequency ON : OFF = 1 s : 9 s)	
90 A 60 V DC	Min. 10 ³ ope. (at 85°C, switching frequency ON : OFF = 1 s : 9 s)			

Power relays (Over 2 A) HE RELAYS PV Type

REFERENCE DATA

1-1. Max. switching capacity (AC Resistive load)

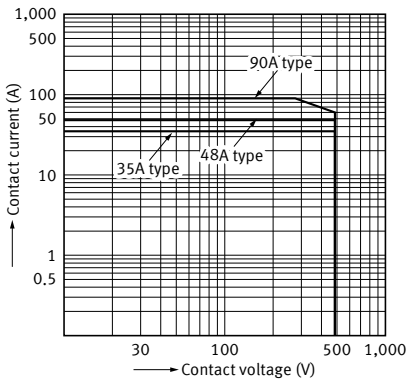

1-2. Max. switching capacity (DC Resistive load)

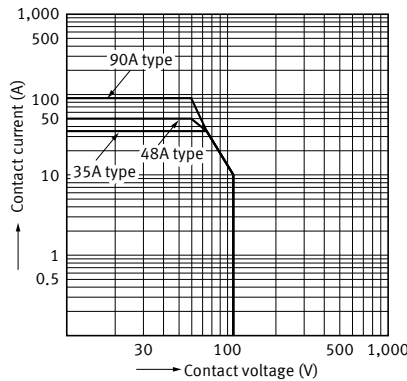

2-1. Coil temperature characteristics (35 A type: Average)

Tested sample : HE 1a N-P-DC 9V-H18, 6 pcs.
Measured portion : Coil inside
Contact carrying current : 35A
Ambient temperature : 25°C, 60°C, 85°C

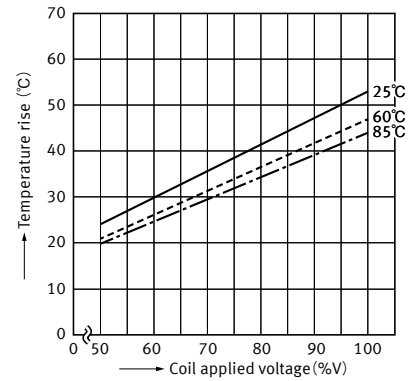

2-2. Coil temperature characteristics (48 A type: Average)

Tested sample : HE 1a N-P-DC 9V-Y5, 6 pcs.
Measured portion : Coil inside
Contact carrying current : 48A
Ambient temperature : 25°C, 60°C, 85°C

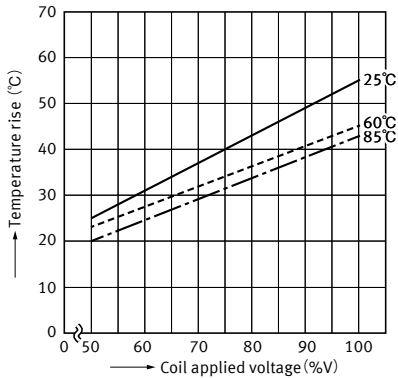

2-3. Coil temperature characteristics (90 A type: Average)

Tested sample : HE 1a N-W-DC 12V-Y6, 6 pcs.
Measured portion : Coil inside
Contact carrying current : 90A
Ambient temperature : 25°C, 60°C, 85°C

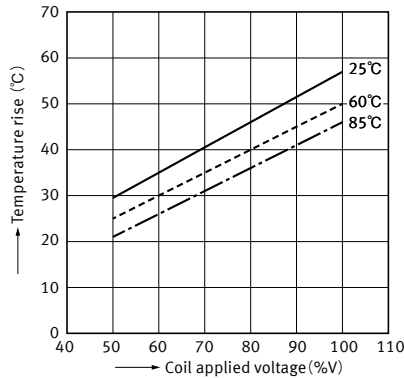

3. Ambient temperature characteristics

Test sample : HE-PV (35A, 48A, 90A), 3pcs.

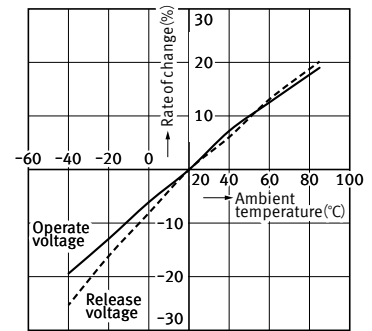

4-1. Electrical life test (35 A type: resistive load 277 V AC 35 A, at 85°C)

Tested sample : HE 1a N-P-DC 9V-H18, 6 pcs.
Operation frequency : 6 times/min.
(ON : OFF=1s : 9s)

Circuit :

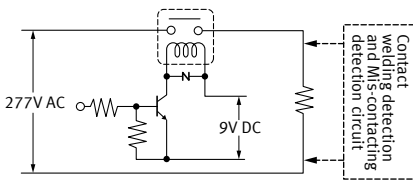

Operate and release voltage

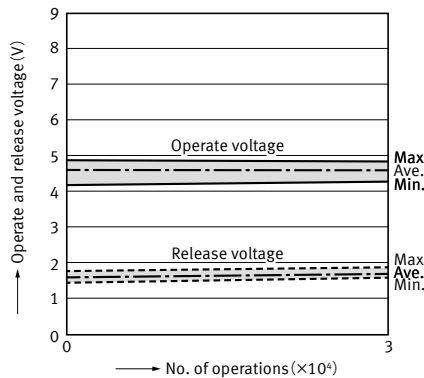

Change of contact resistance

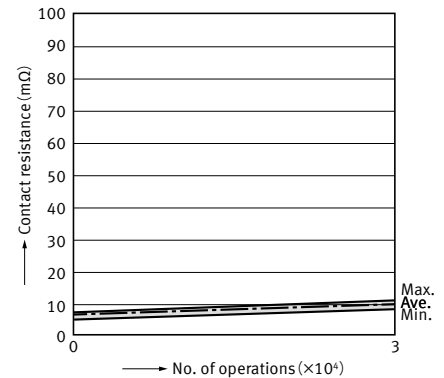

4-2. Electrical life test (48 A type: resistive load 277 V AC 48 A, at 85°C)

Tested sample : HE 1a N-P-DC 9V-Y5, 6 pcs.
 Operation frequency : 6 times/min.
 (ON : OFF=1s : 9s)

Circuit :

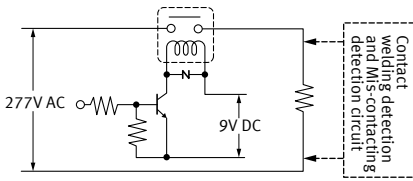

Operate and release voltage

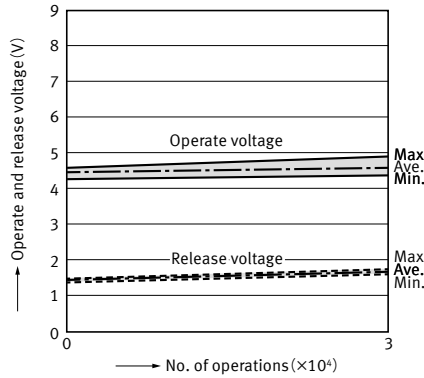

Change of contact resistance

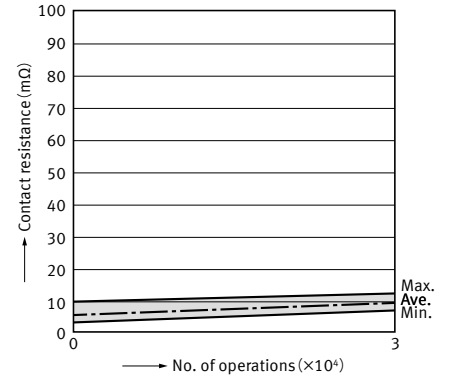

4-3. Electrical life test (90 A type: resistive load 277 V AC 80 A, at 25°C)

Tested sample : HE 1a N-W-DC12V-Y6, 6 pcs.
 Operation frequency : 6 times/min.
 (ON : OFF=1s : 9s)

Circuit :

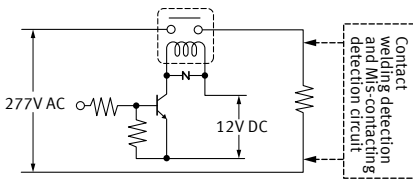

Operate and release voltage

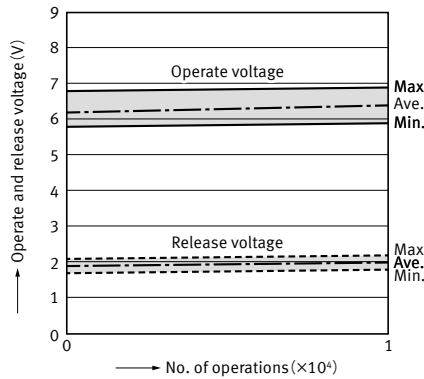

Change of contact resistance

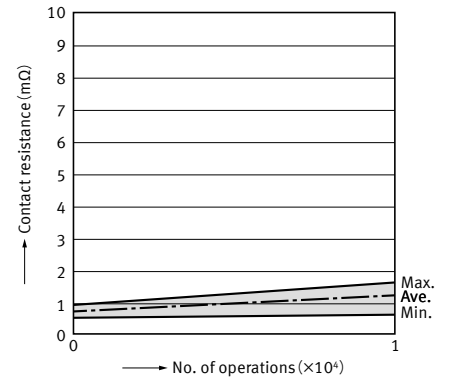

DIMENSIONS

CAD The CAD data of the products with a "CAD" mark can be downloaded from our Website.

Unit: mm

35 A type

CAD



External dimensions

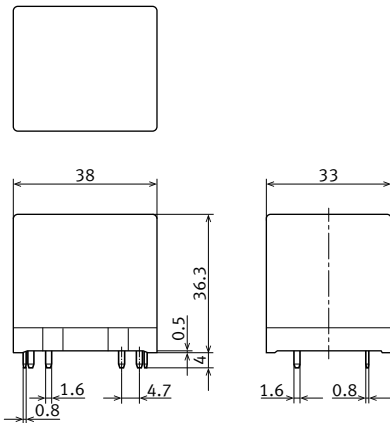

Recommended PC board pattern (BOTTOM VIEW)

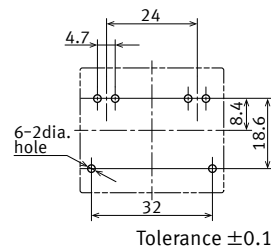

Schematic (BOTTOM VIEW)

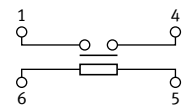

General tolerance
 Less than 1mm : ±0.1
 Min. 1mm less than 3mm : ±0.2
 Min. 3mm : ±0.3

Note: Terminal dimensions are values without pre-soldering thickness.

Power relays (Over 2 A) HE RELAYS PV Type

■ 48 A type

CAD

External dimensions

Recommended PC board pattern
(BOTTOM VIEW)

Schematic
(BOTTOM VIEW)

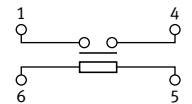
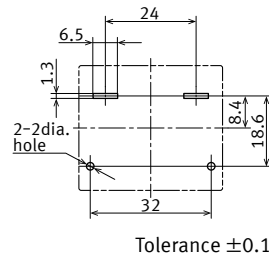
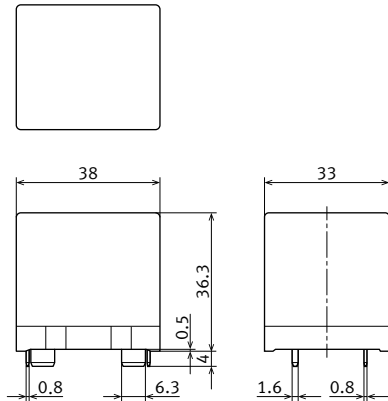

General tolerance
Less than 1mm : ± 0.1
Min. 1mm less than 3mm : ± 0.2
Min. 3mm : ± 0.3

Note: Terminal dimensions are values without pre-soldering thickness.

■ 90 A type

CAD

External dimensions

Recommended PC board pattern
(BOTTOM VIEW)

Schematic
(BOTTOM VIEW)

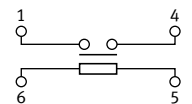
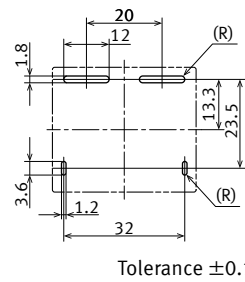
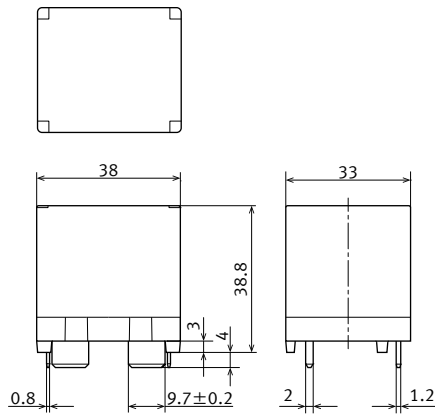

General tolerance
Less than 1mm : ± 0.1
Min. 1mm less than 3mm : ± 0.2
Min. 3mm : ± 0.3

Note: Terminal dimensions are values without pre-soldering thickness.

SAFETY STANDARDS

Each standard may be updated at any time, so please check our Website for the latest information.

UL (Approved)

35 A type

File No.	Contact rating	Operations
E43028	35 A 277 V AC	10 × 10 ³
	30 A 277 V AC	100 × 10 ³
	30 A 30 V DC	100 × 10 ³
	3 HP 250 V AC	100 × 10 ³
	1.5 HP 125 V AC	100 × 10 ³

UL/C-UL (Approved)

48 A type

File No.	Contact rating	Operations	Ambient temperature
E43028	60 A 277 V AC	10 × 10 ³	60°C
	48 A 277 V AC	30 × 10 ³	85°C

90 A type

File No.	Contact rating	Operations	Ambient temperature
E43028	80 A 300 V AC	10 × 10 ³	–
	80 A 300 V AC	6 × 10 ³	85°C

CSA (Approved)

35 A type

File No.	Contact rating	Operations
1011904	35 A 277 V AC	10 × 10 ³
	30 A 277 V AC	100 × 10 ³
	30 A 30 V DC	100 × 10 ³
	3HP 250 V AC	100 × 10 ³
	1.5HP 125 V AC	100 × 10 ³

48 A type, 90 A type

CSA standard approved by C-UL

VDE (Approved)

35 A type

File No.	Contact rating	Operations	Ambient temperature
40006681	35 A 250 V AC (cosφ = 1.0)	50 × 10 ³	80°C

Note) For only 9 V DC coil

48 A type

File No.	Contact rating	Operations	Ambient temperature
40006681	72 A 250 V AC (cosφ = 0.8)	50	85°C
	60 A 250 V AC (cosφ = 0.8)	10 × 10 ³	85°C
	50 A 20 V DC (0 ms)	30 × 10 ³	85°C
	48 A 250 V AC (cosφ = 0.8)	30 × 10 ³	85°C

90 A type

File No.	Contact rating	Operations	Ambient temperature
40006681	90 A 300 V AC (cosφ = 1.0)	10 ³	85°C
	90 A 250 V AC (cosφ = 0.8)	10 ³	85°C
	80 A 250 V AC (cosφ = 1.0)	10 × 10 ³	25°C
	80 A 250 V AC (cosφ = 0.8)	10 × 10 ³	85°C
	135 A 250 V AC (cosφ=0.8)	50	85°C

TV rating

35 A type

File No.	Contact rating
E43028	TV-15

INSULATION CHARACTERISTICS (IEC61810-1)

Item	Characteristics
Clearance/Creepage distance (IEC61810-1)	Min. 5.5 mm/8.0 mm
Category of protection (IEC61810-1)	RT II
Tracking resistance (IEC60112)	PTI 175
Insulation material group	III a
Over voltage category	III
Rated voltage	250 V
Pollution degree	3
Type of insulation (Between contact and coil)	Reinforced insulation
Type of insulation (Between open contact)	Full disconnection

Note: Actual value

GUIDELINES FOR USAGE

■ For cautions for use, please read “GUIDELINES FOR RELAY USAGE”.
https://industrial.panasonic.com/ac/e/control/relay/cautions_use/index.jsp

■ Cautions for usage of HE-PV relay

● Usage, transport and storage conditions

- 1) Ambient temperature : -50 to 85°C
 (When using at 55°C or higher, the coil holding voltage should be 50% V to 60% V)
- 2) Humidity:
 5 to 85% RH (Avoid icing and condensation)
 Note: The humidity range varies with the temperature. Use within the range indicated in the graph below.
- 3) Atmospheric pressure:
 86 to 106 kPa

[Temperature and humidity range for usage, transport and storage]

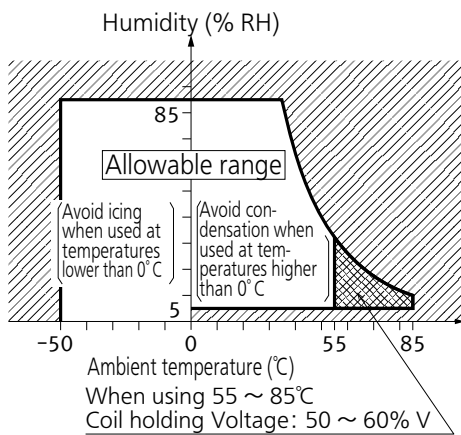

● DC load guidelines

In case the relay is used as a DC high voltage switch, the final failure mode may be uninterruptible. In the event that the power supply cannot be cut off, in the worst case, the fire may spread to the surrounding area. Therefore, configure the power supply so that it can be turned off within one second. Also, consider a fail safe circuit for your equipment.

Use a varistor to absorb the surge of the coil.

If a diode is used, the contact separation speed will be slow and the cutoff performance will be degraded.

< Recommended Varistor >

Energy tolerance: 1 J or more

varistor voltage : 1.5 times or more of the rated coil voltage

When using an inductive load (L load) with $L/R > 1$ ms, take surge absorption measures in parallel with the inductive load.

● About parallel relay connections

When multiple relays are connected in parallel, design the equipment so that the load applied to each relay is within the specified range.

(Concentration of load on one relay leads to early failure.)

● Ambient Atmosphere

If the relay is used or stored in an atmosphere of corrosive gas (Sulfurous acid gas: SO_2 , hydrogen sulfide gas: H_2S), corrosive gas components may adhere to the contacts, resulting in contact failure. Do not use or store the relay in such an atmosphere.

● Method for reducing coil holding voltage

When the coil holding voltage is used by PWM control, the release voltage varies depending on the operating temperature and operating conditions. Therefore, please evaluate the coil holding voltage under the worst operating conditions.

Recommended operating condition:

Periods: 20 kHz to 100 kHz, Duty Ratio: 50%

● About conductor cross-sectional area during mounting

When designing a printed circuit board, ensure that there is sufficient margin in the conductor width and conductor spacing. To reduce the temperature rise, refer to the cross-sectional area of the conductor of UL 508.

GUIDELINES FOR POWER, HIGH-CAPACITY DC CUT OFF AND SAFETY RELAYS USAGE

■ For cautions for use, please read “GUIDELINES FOR RELAY USAGE”.
https://industrial.panasonic.com/ac/e/control/relay/cautions_use/index.jsp

Precautions for Coil Input

■ Long term current carrying

A circuit that will be carrying a current continuously for long periods without relay switching operation. (circuits for emergency lamps, alarm devices and error inspection that, for example, revert only during malfunction and output warnings with form B contacts)
Continuous, long-term current to the coil will facilitate deterioration of coil insulation and characteristics due to heating of the coil itself. For circuits such as these, please use a magnetic-hold type latching relay. If you need to use a single stable relay, use a sealed type relay that is not easily affected by ambient conditions and make a failsafe circuit design that considers the possibility of contact failure or disconnection.

■ DC Coil operating power

Steady state DC current should be applied to the coil. The wave form should be rectangular. If it includes ripple, the ripple factor should be less than 5%.

However, please check with the actual circuit since the electrical characteristics may vary. The rated coil voltage should be applied to the coil and the set/reset pulse time of latching type relay differs for each relays, please refer to the relay's individual specifications.

■ Coil connection

When connecting coils of polarized relays, please check coil polarity (+,-) at the internal connection diagram (Schematic). If any wrong connection is made, it may cause unexpected malfunction, like abnormal heat, fire and so on, and circuit do not work. Avoid impressing voltages to the set coil and reset coil at the same time.

Ambient Environment

■ Usage, Transport, and Storage Conditions

During usage, storage, or transportation, avoid locations subjected to direct sunlight and maintain normal temperature, humidity and pressure conditions.

● Temperature/Humidity/Pressure

When transporting or storing relays while they are tube packaged, there are cases the temperature may differ from the allowable range. In this case be sure to check the individual specifications. Also allowable humidity level is influenced by temperature, please check charts shown below and use relays within mentioned conditions. (Allowable temperature values differ for each relays, please refer to the relay's individual specifications.)

1) Temperature:

The tolerance temperature range differs for each relays, please refer to the relay's individual specifications

2) Humidity: 5 to 85 % RH

3) Pressure: 86 to 106 kPa

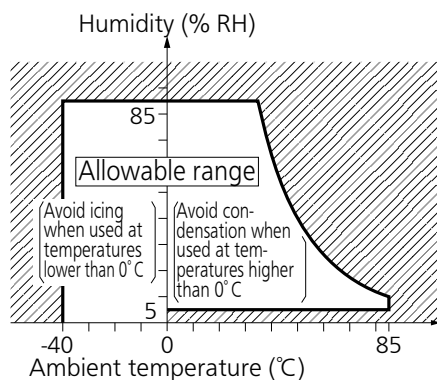

■ Maximum allowable voltage and temperature rise

Proper usage requires that the rated coil voltage be impressed on the coil. Note, however, that if a voltage greater than or equal to the maximum continuous voltage is impressed on the coil, the coil may burn or its layers short due to the temperature rise. Furthermore, do not exceed the usable ambient temperature range listed in the catalog.

■ Operate voltage change due to coil temperature rise

In DC relays, after continuous passage of current in the coil, if the current is turned OFF, then immediately turned ON again, due to the temperature rise in the coil, the operate voltage will become somewhat higher. Also, it will be the same as using it in a higher temperature atmosphere. The resistance/temperature relationship for copper wire is about 0.4% for 1°C, and with this ratio the coil resistance increases. That is, in order to operate of the relay, it is necessary that the voltage be higher than the operate voltage and the operate voltage rises in accordance with the increase in the resistance value. However, for some polarized relays, this rate of change is considerably smaller.

● Dew condensation

Condensation occurs when the ambient temperature drops suddenly from a high temperature and humidity, or the relay is suddenly transferred from a low ambient temperature to a high temperature and humidity. Condensation causes the failures like insulation deterioration, wire disconnection and rust etc. Panasonic Corporation does not guarantee the failures caused by condensation.

The heat conduction by the equipment may accelerate the cooling of device itself, and the condensation may occur.

Please conduct product evaluations in the worst condition of the actual usage. (Special attention should be paid when high temperature heating parts are close to the device. Also please consider the condensation may occur inside of the device.)

● Icing

Condensation or other moisture may freeze on relays when the temperature become lower than 0°C. This icing causes the sticking of movable portion, the operation delay and the contact conduction failure etc. Panasonic Corporation does not guarantee the failures caused by the icing.

The heat conduction by the equipment may accelerate the cooling of relay itself and the icing may occur. Please conduct product evaluations in the worst condition of the actual usage.

● Low temperature and low humidity

The plastic becomes brittle if the switch is exposed to a low temperature, low humidity environment for long periods of time.

● High temperature and high humidity

Storage for extended periods of time (including transportation periods) at high temperature or high humidity levels or in atmospheres with organic gases or sulfide gases may cause a sulfide film or oxide film to form on the surfaces of the contacts and/or it may interfere with the functions. Check out the atmosphere in which the units are to be stored and transported.

● Package

In terms of the packing format used, make every effort to keep the effects of moisture, organic gases and sulfide gases to the absolute minimum.

● Silicon

When a source of silicone substances (silicone rubber, silicone oil, silicone coating materials and silicone filling materials etc.) is used around the relay, the silicone gas (low molecular siloxane etc.) may be produced.

This silicone gas may penetrate into the inside of the relay. When the relay is kept and used in this condition, silicone compound may adhere to the relay contacts which may cause the contact failure.

Do not use any sources of silicone gas around the relay (Including plastic seal types).

● NOx Generation

When relay is used in an atmosphere high in humidity to switch a load which easily produces an arc, the NOx created by the arc and the water absorbed from outside the relay combine to produce nitric acid.

This corrodes the internal metal parts and adversely affects operation.

Avoid use at an ambient humidity of 85%RH or higher (at 20°C). If use at high humidity is unavoidable, please contact our sales representative.

Others

■ Cleaning

• Although the environmentally sealed type relay (plastic sealed type, etc.) can be cleaned, avoid immersing the relay into cold liquid (such as cleaning solvent) immediately after soldering. Doing so may deteriorate the sealing performance.

• Cleaning with the boiling method is recommended(The temperature of cleaning liquid should be 40°C or lower).

Avoid ultrasonic cleaning on relays. Use of ultrasonic cleaning may cause breaks in the coil or slight sticking of the contacts due to ultrasonic energy.

Please refer to **"the latest product specifications"** when designing your product.

•Requests to customers:

<https://industrial.panasonic.com/ac/e/salespolicies/>

Please contact

Panasonic Corporation

Electromechanical Control Business Division

■1006, Oaza Kadoma, Kadoma-shi, Osaka 571-8506, Japan
industrial.panasonic.com/ac/e/

Panasonic[®]

©Panasonic Corporation 2021