

DE RELAYS

Compliant with European safety standards, 1 Form A/2 Form A/1 Form A 1 Form B 10 A/8 A Polarized power relays

Protective construction : Sealed type

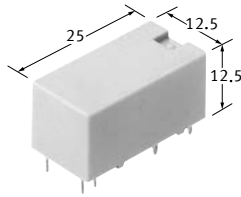

(Unit : mm)

FEATURES

- Variety of contact arrangements (1 Form A, 2 Form A, 1 Form A 1 Form B)
- Compliant with European safety standards (EN60730-1, EN60335-1) reinforced insulation
- Insulating distance: Min. 8 mm (Clearance, Creepage)
- Latching types available

TYPICAL APPLICATIONS

- Temperature controller
- Automatic meter reading system
- OA equipment
- Industrial equipment
- Lighting control system

ORDERING INFORMATION (PART NO. : Ordering part number for Japanese market)

ADE

● Contact arrangement	● Operating function	● Rated coil voltage(DC)
1 : 1 Form A	0 : Single side stable	Part No. 3 4 9
2 : 2 Form A	2 : 2 coil latching	Rated coil voltage(V) 12 24 5
3 : 1 Form A 1 Form B		

Note: This product is manufactured by lot after an order is received.

ORDERING INFORMATION (TYPE NO. : Ordering part number for non Japanese market)

DE

● Contact arrangement	● Operating function	● Rated coil voltage(DC)
1a : 1 Form A	Nil: Single side stable	5, 12, 24V
2a : 2 Form A	L2: 2 coil latching	
1a1b: 1 Form A 1 Form B		

Note: This product is manufactured by lot after an order is received.

Power relays (Over 2 A) DE RELAYS

TYPES

" Type No. " is ordering part number for non Japanese market. " Part No. " is ordering part number for Japanese market.

Contact arrangement	Rated coil voltage	Single side stable		2 coil latching		Standard packing	
		Type No.	Part No.	Type No.	Part No.	Inner carton (1-tube)	Outer carton
1 Form A	5 V DC	DE1a-5V	ADE109	DE1a-L2-5V	ADE129	20 pcs.	500 pcs.
	12 V DC	DE1a-12V	ADE103	DE1a-L2-12V	ADE123		
	24 V DC	DE1a-24V	ADE104	DE1a-L2-24V	ADE124		
1 Form A 1 Form B	5 V DC	DE1a1b-5V	ADE309	DE1a1b-L2-5V	ADE329		
	12 V DC	DE1a1b-12V	ADE303	DE1a1b-L2-12V	ADE323		
	24 V DC	DE1a1b-24V	ADE304	DE1a1b-L2-24V	ADE324		
2 Form A	5 V DC	DE2a-5V	ADE209	DE2a-L2-5V	ADE229		
	12 V DC	DE2a-12V	ADE203	DE2a-L2-12V	ADE223		
	24 V DC	DE2a-24V	ADE204	DE2a-L2-24V	ADE224		

RATING

Coil data

- Operating characteristics such as 'Operate voltage' and 'Release voltage' are influenced by mounting conditions, ambient temperature, etc. Therefore, please use the relay within $\pm 5\%$ of rated coil voltage.
- 'Initial' means the condition of products at the time of delivery.

Single side stable

Rated coil voltage	Operate voltage* (at 20°C)	Release voltage* (at 20°C)	Rated operating current ($\pm 10\%$, at 20°C)	Coil resistance ($\pm 10\%$, at 20°C)	Rated operating power	Max. allowable voltage (at 20°C)
5 V DC	Max. 70% V of rated coil voltage (Initial)	Min. 10% V of rated coil voltage (Initial)	40 mA	125 Ω	200 mW	130% V of rated coil voltage
12 V DC			16.6 mA	720 Ω		
24 V DC			8.3 mA	2,880 Ω		

*square, pulse drive

2 coil latching

Rated coil voltage	Set voltage* (at 20°C)	Reset voltage* (at 20°C)	Rated operating current ($\pm 10\%$, at 20°C)		Coil resistance ($\pm 10\%$, at 20°C)		Rated operating power		Max. allowable voltage (at 20°C)
			Set coil	Reset coil	Set coil	Reset coil	Set coil	Reset coil	
5 V DC	Max. 70% V of rated coil voltage (Initial)	Max. 70% V of rated coil voltage (Initial)	40 mA	40 mA	125 Ω	125 Ω	200 mW	200 mW	130% V of rated coil voltage
12 V DC			16.6 mA	16.6 mA	720 Ω	720 Ω			
24 V DC			8.3 mA	8.3 mA	2,880 Ω	2,880 Ω			

*square, pulse drive

■ Specifications

Item		Specifications		
Contact data	Contact arrangement	1 Form A	1 Form A 1 Form B	2 Form A
	Contact resistance (initial)	Max. 30 mΩ (by voltage drop 6 V DC 1 A)		
	Contact material	AgSnO ₂ type		
	Contact rating (resistive)	10 A 250 V AC, 10 A 30 V DC	8 A 250 V AC, 8 A 30 V DC	
	Max. switching power (resistive)	2,500 VA (AC), 300 W (DC)	2,000 VA (AC), 240 W (DC)	
	Max. switching voltage	250 V AC, 30 V DC		
	Max. switching current	10 A	8 A	
	Min. switching load (reference value)*1	100 mA 5 V DC		
Insulation resistance (initial)		Min. 1,000 MΩ (at 500 V DC, Measured portion is the same as the case of dielectric strength.)		
Dielectric strength (initial)	Between open contacts	1,000 Vrms for 1 min (detection current: 10 mA)		
	Between contact sets	–	4,000 Vrms for 1 min (detection current: 10 mA)	
	Between contact and coil	5,000 Vrms for 1 min (detection current: 10 mA)		
Surge withstand voltage (initial)*2	Between contact and coil	12,000 V		
Time characteristics (initial)	Operate (Set) time	Max. 10 ms [Max. 10 ms] at rated coil voltage (at 20°C, without bounce)		
	Release (Reset) time	Max. 5 ms [Max. 10 ms] at rated coil voltage (at 20°C, without bounce, without diode)		
Shock resistance	Functional	196 m/s ² (half-sine shock pulse: 11 ms, detection time: 10 μs)		
	Destructive	980 m/s ² (half-sine shock pulse: 6 ms)		
Vibration resistance	Functional	10 to 55 Hz (at double amplitude of 2 mm, detection time: 10 μs)		
	Destructive	10 to 55 Hz (at double amplitude of 3 mm)		
Expected life	Mechanical life	Min. 10 x 10 ⁶ (switching frequency: 300 times/min.)		
Conditions	Conditions for usage, transport and storage*3	Ambient temperature: -40 to +70°C (Allowable temperature is from -40 to +60°C at our standard packing condition.) Humidity: 5 to 85% RH (Avoid icing and condensation)		
Unit weight		Approx. 7 g		

*1. This value can change due to the switching frequency, environmental conditions, and desired reliability level, therefore it is recommended to check this with the actual load.

*2. Wave is standard shock voltage of $\pm 1.2 \times 50 \mu\text{s}$ according to JEC-212-1981

*3. For ambient temperature, please read "GUIDELINES FOR RELAY USAGE".

■ Expected electrical life

Conditions: Resistive load, Switching frequency 20 times/min

Type	Switching capacity	Number of operations
1 Form A	10 A 250 V AC	Min. 100 x 10 ³
	10 A 30 V DC	Min. 100 x 10 ³
1 Form A 1 Form B	8 A 250 V AC	Min. 100 x 10 ³
	8 A 30 V DC	Min. 100 x 10 ³
2 Form A	8 A 250 V AC	Min. 100 x 10 ³
	8 A 30 V DC	Min. 50 x 10 ³

REFERENCE DATA

1-1. Max. switching capacity (1 Form A)

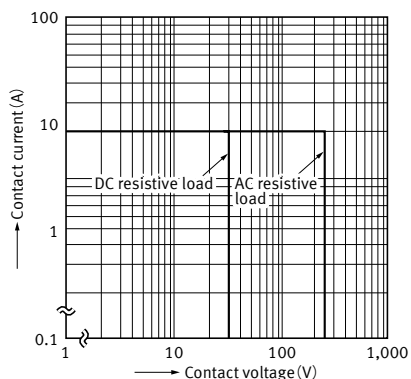

1-2. Max. switching capacity (1 Form A
1 Form B, 2 Form A)

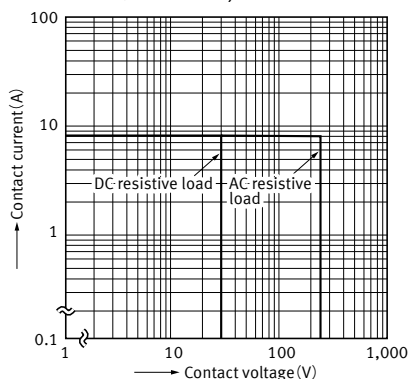

2-1. Switching life curve (1 Form A)

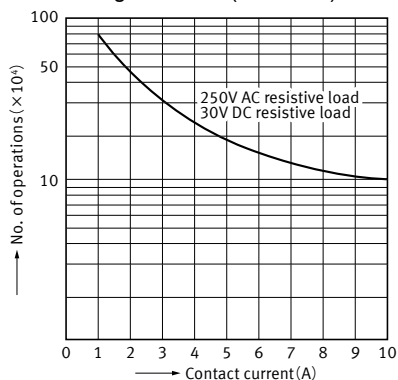

2-2. Switching life curve (1 Form A 1 Form B) 2-3. Switching life curve (2 Form A)

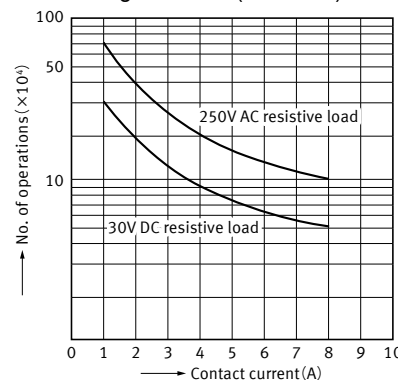
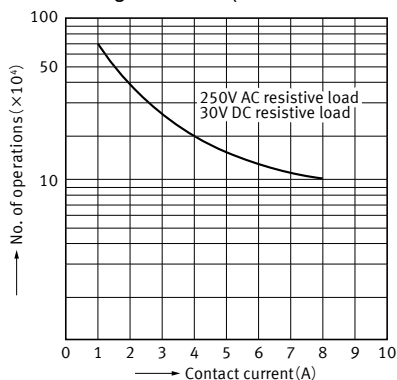

3-1. Coil temperature characteristics
(1 Form A: Average)

Tested sample : DE1a-5V, 6 pcs.
Ambient temperature : 25°C, 70°C

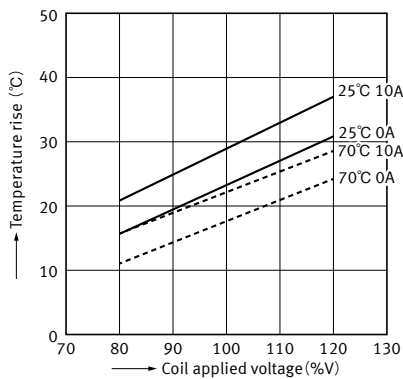

3-2. Coil temperature characteristics
(1 Form A 1 Form B: Average)

Tested sample : DE1a1b-5V, 6 pcs.
Ambient temperature : 25°C, 70°C

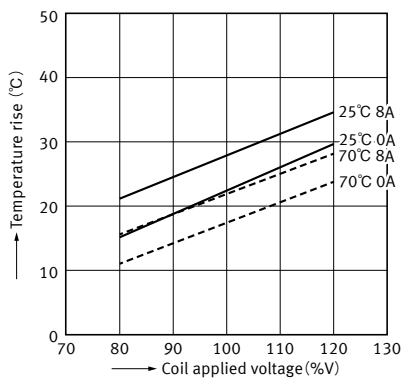

3-3. Coil temperature characteristics
(2 Form A: Average)

Tested sample : DE2a-5V, 6 pcs.
Ambient temperature : 25°C, 70°C

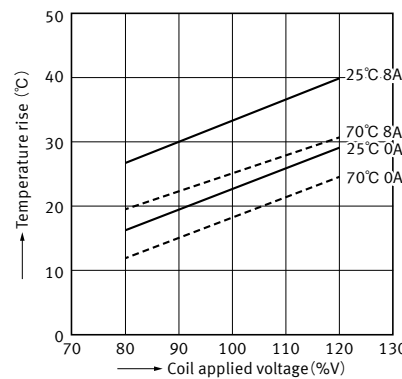

4-1. Ambient temperature characteristics
(1 Form A: Average)

Tested sample : DE1a-5V, 6 pcs.
Ambient temperature : -40 to +80°C

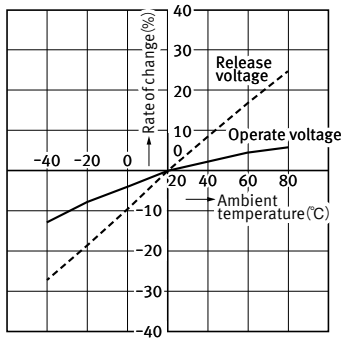

4-2. Ambient temperature characteristics
(1 Form A 1 Form B: Average)

Tested sample : DE1a1b-5V, 6 pcs.
Ambient temperature : -40 to +80°C

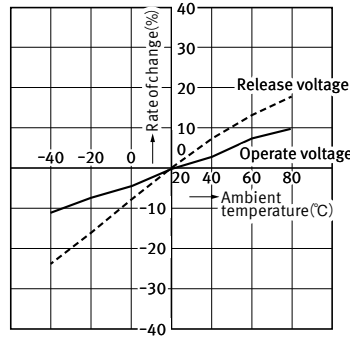

4-3. Ambient temperature characteristics
(2 Form A: Average)

Tested sample : DE2a-5V, 6 pcs.
Ambient temperature : -40 to +80°C

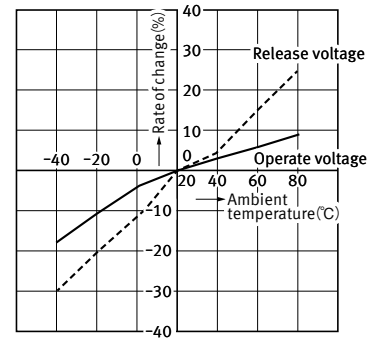

5-1. Operate and release time (1 Form A)

Tested sample : DE1a-5V, 5 pcs.

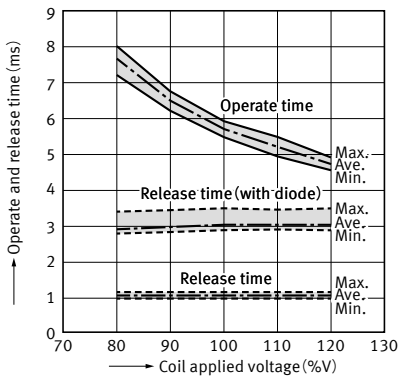

5-2. Operate and release time (1 Form A 1 Form B)

Tested sample : DE1a1b-5V, 5 pcs.

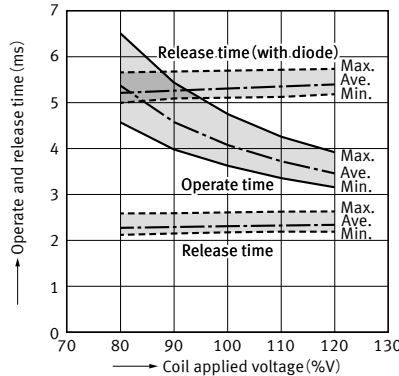

5-3. Operate and release time (2 Form A)

Tested sample : DE2a-5V, 5 pcs.

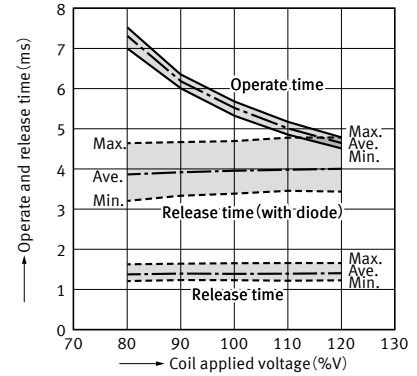

DIMENSIONS

CAD The CAD data of the products with a "CAD" mark can be downloaded from our Website.

Unit: mm

● Single side stable

CAD

External dimensions

Recommended PC board pattern
(BOTTOM VIEW)

Schematic
(BOTTOM VIEW)
(De-energize)
1 Form A

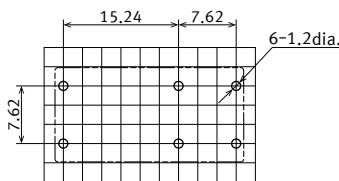
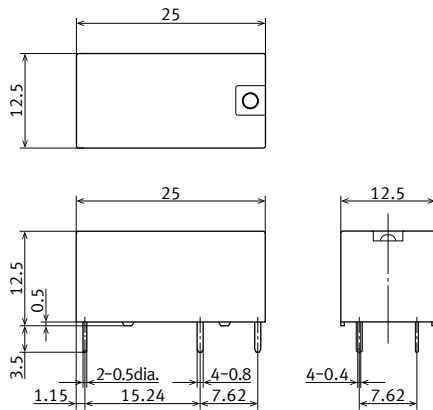

Tolerance ± 0.1

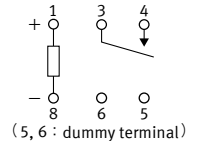

1 Form A 1 Form B

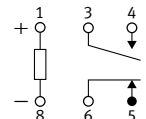

2 Form A

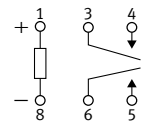

Power relays (Over 2 A) DE RELAYS

● 2 coil latching

CAD



External dimensions

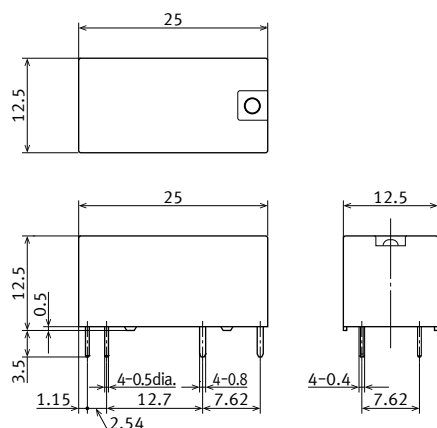

General tolerance ± 0.3

Recommended PC board pattern (BOTTOM VIEW)

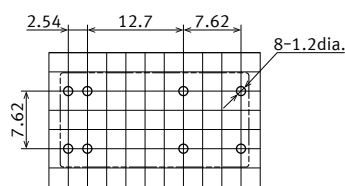

Tolerance ± 0.1

Schematic (BOTTOM VIEW)

(Reset)
1 Form A

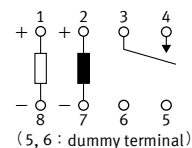

1 Form A 1 Form B

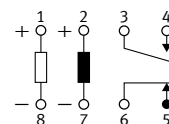

2 Form A

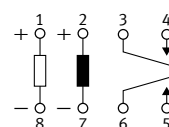

SAFETY STANDARDS

Each standard may be updated at any time, so please check our Website for the latest information.

UL/C-UL (Recognized)

1 Form A

File No.	Contact rating	Operations
E120782	12 A 120 V AC General use	30×10^3
	10 A 277 V AC Ballast	-
	8 A 277 V AC General use	-
	8 A 120 V AC Lamp Load	30×10^3
	6 A 347 V AC General use	30×10^3
	2 A 480 V AC Resistive	100×10^3
	1 HP 277 V AC	-
Pilot Duty B300, R300*	-	

*Pilot Duty comply with UL508 conditions

1 Form A 1 Form B

File No.	Contact rating	Operations
E120782	8.5 A 120 V AC General use	30×10^3
	6 A 277 V AC General use	30×10^3
	6 A 120 V AC Lamp Load	30×10^3
	4.5 A 347 V AC General use	30×10^3
	2 A 480 V AC Resistive	100×10^3
	0.7 HP 277 V AC	-
	Pilot Duty B300, R300*	-

*Pilot Duty comply with UL508 conditions

2 Form A

File No.	Contact rating	Operations
E120782	12 A 120 V AC General use	30×10^3
	10 A 277 V AC Ballast	-
	8 A 120 V AC Lamp Load	30×10^3
	8 A 277 V AC General use	-
	6 A 347 V AC General use	30×10^3
	2 A 480 V AC Resistive	100×10^3
	1 HP 277 V AC	-
	Pilot Duty B300, R300*	-

*Pilot Duty comply with UL508 conditions

CSA (Certified)

CSA standard certified by C-UL

■ VDE (Certified)

1 Form A

File No.	Contact rating	Operations	Ambient temperature
115944	16 A 250 V AC ($\cos\phi=1.0$)	5×10^5	70°C
	8 A 250 V AC ($\cos\phi=1.0$)	150×10^3	70°C

1 Form A 1 Form B

File No.	Contact rating	Operations	Ambient temperature
115944	16 A 250 V AC ($\cos\phi=1.0$)	5×10^5	70°C
	8 A 250 V AC ($\cos\phi=1.0$)	150×10^3	70°C

2 Form A

File No.	Contact rating	Operations	Ambient temperature
115944	8 A 250 V AC ($\cos\phi=1.0$)	150×10^3	70°C

INSULATION CHARACTERISTICS (IEC61810-1)

Item	Characteristics
Clearance/Creepage distance (IEC61810-1)	Min. 8.0/8.0 mm
Category of protection (IEC61810-1)	RT III
Tracking resistance (IEC60112)	PTI 175
Insulation material group	III a
Over voltage category	III
Rated voltage	250 V
Pollution degree	3
Type of insulation (Between contact and coil)	Reinforced insulation
Type of insulation (Between open contacts)	Micro disconnection

Note: EN/IEC VDE Certified.

GUIDELINES FOR USAGE

- For cautions for use, please read “GUIDELINES FOR RELAY USAGE”.
https://industrial.panasonic.com/ac/e/control/relay/cautions_use/index.jsp

GUIDELINES FOR POWER, HIGH-CAPACITY DC CUT OFF AND SAFETY RELAYS USAGE

■ For cautions for use, please read “GUIDELINES FOR RELAY USAGE”.
https://industrial.panasonic.com/ac/e/control/relay/cautions_use/index.jsp

Precautions for Coil Input

■ Long term current carrying

A circuit that will be carrying a current continuously for long periods without relay switching operation. (circuits for emergency lamps, alarm devices and error inspection that, for example, revert only during malfunction and output warnings with form B contacts)
Continuous, long-term current to the coil will facilitate deterioration of coil insulation and characteristics due to heating of the coil itself. For circuits such as these, please use a magnetic-hold type latching relay. If you need to use a single stable relay, use a sealed type relay that is not easily affected by ambient conditions and make a failsafe circuit design that considers the possibility of contact failure or disconnection.

■ DC Coil operating power

Steady state DC current should be applied to the coil. The wave form should be rectangular. If it includes ripple, the ripple factor should be less than 5%.

However, please check with the actual circuit since the electrical characteristics may vary. The rated coil voltage should be applied to the coil and the set/reset pulse time of latching type relay differs for each relays, please refer to the relay's individual specifications.

■ Coil connection

When connecting coils of polarized relays, please check coil polarity (+,-) at the internal connection diagram (Schematic). If any wrong connection is made, it may cause unexpected malfunction, like abnormal heat, fire and so on, and circuit do not work. Avoid impressing voltages to the set coil and reset coil at the same time.

■ Maximum allowable voltage and temperature rise

Proper usage requires that the rated coil voltage be impressed on the coil. Note, however, that if a voltage greater than or equal to the maximum continuous voltage is impressed on the coil, the coil may burn or its layers short due to the temperature rise. Furthermore, do not exceed the usable ambient temperature range listed in the catalog.

■ Operate voltage change due to coil temperature rise

In DC relays, after continuous passage of current in the coil, if the current is turned OFF, then immediately turned ON again, due to the temperature rise in the coil, the operate voltage will become somewhat higher. Also, it will be the same as using it in a higher temperature atmosphere. The resistance/temperature relationship for copper wire is about 0.4% for 1°C, and with this ratio the coil resistance increases. That is, in order to operate of the relay, it is necessary that the voltage be higher than the operate voltage and the operate voltage rises in accordance with the increase in the resistance value. However, for some polarized relays, this rate of change is considerably smaller.

Ambient Environment

■ Usage, Transport, and Storage Conditions

During usage, storage, or transportation, avoid locations subjected to direct sunlight and maintain normal temperature, humidity and pressure conditions.

● Temperature/Humidity/Pressure

When transporting or storing relays while they are tube packaged, there are cases the temperature may differ from the allowable range. In this case be sure to check the individual specifications. Also allowable humidity level is influenced by temperature, please check charts shown below and use relays within mentioned conditions. (Allowable temperature values differ for each relays, please refer to the relay's individual specifications.)

1) Temperature:

The tolerance temperature range differs for each relays, please refer to the relay's individual specifications

2) Humidity: 5 to 85 % RH

3) Pressure: 86 to 106 kPa

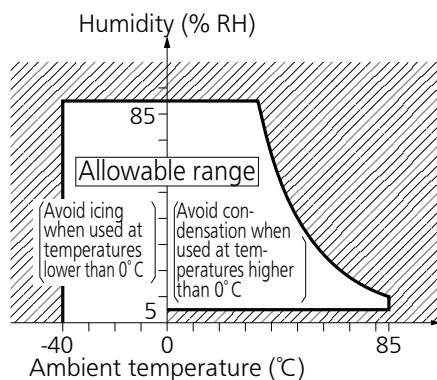

● Dew condensation

Condensation occurs when the ambient temperature drops suddenly from a high temperature and humidity, or the relay is suddenly transferred from a low ambient temperature to a high temperature and humidity. Condensation causes the failures like insulation deterioration, wire disconnection and rust etc. Panasonic Corporation does not guarantee the failures caused by condensation.

The heat conduction by the equipment may accelerate the cooling of device itself, and the condensation may occur.

Please conduct product evaluations in the worst condition of the actual usage. (Special attention should be paid when high temperature heating parts are close to the device. Also please consider the condensation may occur inside of the device.)

● Icing

Condensation or other moisture may freeze on relays when the temperature become lower than 0°C. This icing causes the sticking of movable portion, the operation delay and the contact conduction failure etc. Panasonic Corporation does not guarantee the failures caused by the icing.

The heat conduction by the equipment may accelerate the cooling of relay itself and the icing may occur. Please conduct product evaluations in the worst condition of the actual usage.

● Low temperature and low humidity

The plastic becomes brittle if the switch is exposed to a low temperature, low humidity environment for long periods of time.

● High temperature and high humidity

Storage for extended periods of time (including transportation periods) at high temperature or high humidity levels or in atmospheres with organic gases or sulfide gases may cause a sulfide film or oxide film to form on the surfaces of the contacts and/or it may interfere with the functions. Check out the atmosphere in which the units are to be stored and transported.

● Package

In terms of the packing format used, make every effort to keep the effects of moisture, organic gases and sulfide gases to the absolute minimum.

● Silicon

When a source of silicone substances (silicone rubber, silicone oil, silicone coating materials and silicone filling materials etc.) is used around the relay, the silicone gas (low molecular siloxane etc.) may be produced.

This silicone gas may penetrate into the inside of the relay. When the relay is kept and used in this condition, silicone compound may adhere to the relay contacts which may cause the contact failure.

Do not use any sources of silicone gas around the relay (Including plastic seal types).

● NOx Generation

When relay is used in an atmosphere high in humidity to switch a load which easily produces an arc, the NOx created by the arc and the water absorbed from outside the relay combine to produce nitric acid.

This corrodes the internal metal parts and adversely affects operation.

Avoid use at an ambient humidity of 85%RH or higher (at 20°C). If use at high humidity is unavoidable, please contact our sales representative.

Others

■ Cleaning

• Although the environmentally sealed type relay (plastic sealed type, etc.) can be cleaned, avoid immersing the relay into cold liquid (such as cleaning solvent) immediately after soldering. Doing so may deteriorate the sealing performance.

• Cleaning with the boiling method is recommended(The temperature of cleaning liquid should be 40°C or lower).

Avoid ultrasonic cleaning on relays. Use of ultrasonic cleaning may cause breaks in the coil or slight sticking of the contacts due to ultrasonic energy.

Please refer to **"the latest product specifications"** when designing your product.

•Requests to customers:

<https://industrial.panasonic.com/ac/e/salespolicies/>

Please contact

Panasonic Corporation

Electromechanical Control Business Division

■1006, Oaza Kadoma, Kadoma-shi, Osaka 571-8506, Japan
industrial.panasonic.com/ac/e/

Panasonic[®]

©Panasonic Corporation 2021