

Detector Switch Micro Switch Type with Female Connector Terminal

SPVQ5 Series



A connector type detector switch eliminates the need for solder.

Detector

Push

Slide

Rotary

Encoders

Power

Dual-in-line
Package Type

TACT Switch™

Custom-
Products

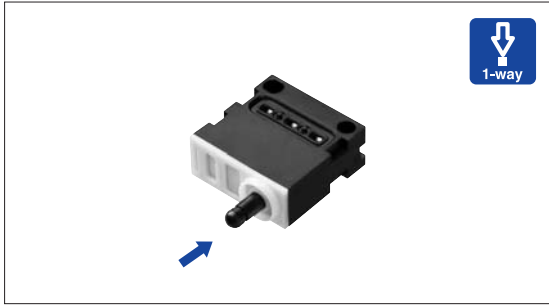

Typical Specifications

Items		Specifications
Rating (max.) / (min.) (Resistive load)		0.1A 12V DC/50μA 5V DC
Contact resistance (Initial/After operating life)		500mΩ max./1Ω max.
Operating force		2N max.
Operating life	Without load	300,000cycles
	With load	300,000cycles (0.1A 12V DC)

Product Line

Poles	Positions	Terminal type	Minimum order unit (pcs)	Product No.
1	2	Female connector type	7,500	SPVQ510101

Packing Specifications

Bulk

Number of packages (pcs.)		Export package measurements (mm)
1 case /Japan	1 case /export packing	
1,500	7,500	389×276×380

Dimensions

Unit:mm

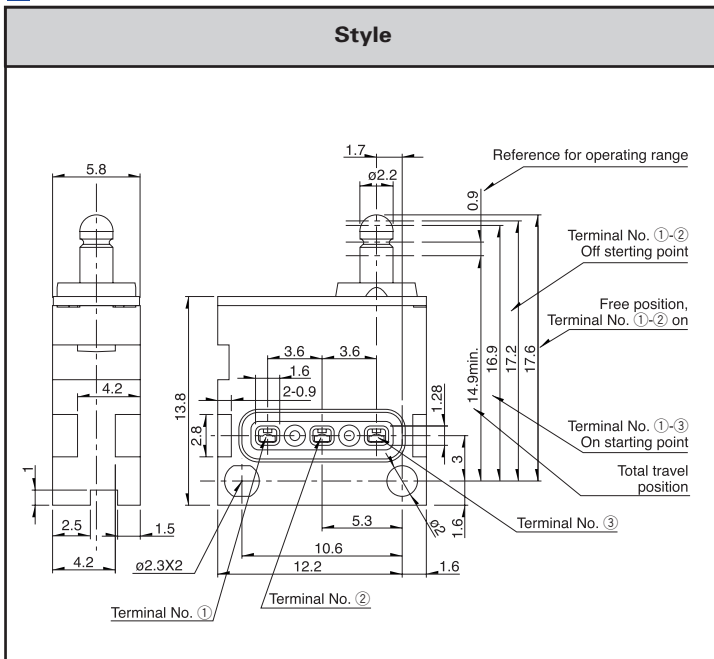

Terminal Type

Unit:mm

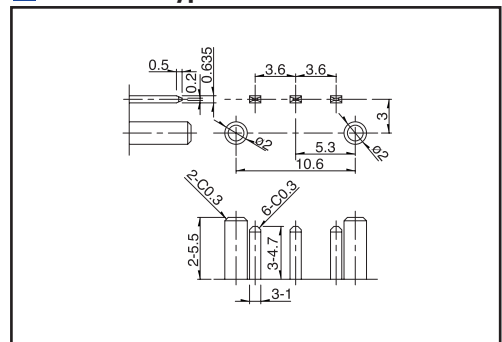

Circuit Diagram

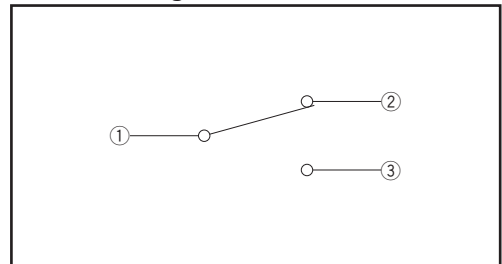

















Note

Please place purchase orders per minimum order unit N (integer).



List of Varieties (General-purpose Type / Water-proof Type / Telephone-hook Type)

Series	General-purpose Type					Water-proof Type		
	SPVT	SPVG	SPVL	SSCW	SPVQ5	SPVQ1	SPVQ3	
Photo								
Operation type						 	 	
Operating temperature range	-40°C to +85°C							
Automotive use	●	●	●	●	●	●	●	
Rating (max.) (Resistive load)	1mA 5V DC	50mA 20V DC	1mA 5V DC	0.1A 12V DC				
Rating (min.) (Resistive load)	100μA 3V DC		50μA 3V DC	100μA 3V DC	50μA 3V DC		50μA 3V DC or 1mA 5V DC	
Electrical performance	Initial contact resistance	2Ω max.	500mΩ max.	2Ω max.	500mΩ max.			
	Insulation resistance	100MΩ min. 100V DC			100MΩ min. 250V DC	100MΩ min. 500V DC		
	Voltage proof	100V AC for 1 minute			250V AC for 1 minute	500V AC for 1 minute		
Mechanical performance	Terminal strength	0.5N for 1 minute		1N for 1 minute	3N for 1 minute Wire strength 30N for 1 minute			
	Actuator strength	10N		5N	20N			
Durability	Operating life without Load	100,000cycles 5Ω max.	100,000cycles 1Ω max.	50,000cycles 5Ω max.	100,000cycles 1Ω max.	300,000cycles 1Ω max.	300,000cycles or 1,200,000cycles 1Ω max.	
	Operating life with Load	(1mA 5V DC) 100,000cycles 5Ω max.	(50mA 20V DC) 100,000cycles 1Ω max.	(1mA 5V DC) 50,000cycles 5Ω max.	(0.1A 12V DC) 100,000cycles 1Ω max.	(0.1A 12V DC) 300,000cycles 1Ω max.	(0.1A 12V DC) 300,000cycles or 1,200,000 1Ω max.	
Environmental performance	Cold	-40±2°C for 96h	-40±2°C for 500h					
	Dry heat	85±2°C for 96h	85±2°C for 500h					
	Damp heat	40±2°C, 90 to 95%RH for 96h	60±2°C, 90 to 95%RH for 500h					
Dimensions (mm)	W	5.6	5.5	5.55	13.1	13.8	13.3	13
	D	6.5	6.5	6.6	11.35	5.8		
	H	1.9	2	1	5.3	5.8	8	8.35
Soldering	Manual soldering	350±5°C, 3s max.					300±10°C, 3 ⁺¹ s	
	Dip soldering	—					260±5°C, 5±1s	
	Reflow soldering	Please see P.102						
Number of poles	1							
Operation force	0.4N max.		0.35N max.	1N max.	2N max.	2N max. 5.9N max.	3N max.	
Page	71	74	79	80	81	82	86	

Detector

Push

Slide

Rotary

Encoders

Power

Dual-in-line
Package Type

TACT Switch™

Custom-
Products

● Detector Switches Soldering Conditions102

● Detector Switches Cautions103