

Detector Switch Water-proof Type

SPVQ4 Series

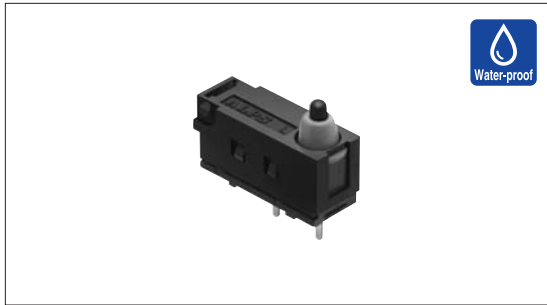

Ensures a highly reliable contact even in the minute electric current range.



Typical Specifications

Items		Specifications
Rating (max.) / (min.) (Resistive load)		0.1A 12V DC/50 μ A 3V DC
Voltage drop (Initial/After operating life)		0.2V max./0.3V max.
Operating force		1 \pm 0.3N
Operating life	Without load	300,000cycles
	With load	300,000cycles (0.1A 12V DC)

Product Line

Poles	Positions	Operating part shape	Terminal type	Main body form	Minimum order unit (pcs)	Product No.	Drawing No.
1	1	Push	For PC board	Boss - left side	6,000	SPVQ440300	1
				Boss - right side		SPVQ440400	2

Packing Specifications

Bulk

Number of packages (pcs.)		Export package measurements (mm)
1 case /Japan	1 case /export packing	
1,500	6,000	540 \times 360 \times 270

Dimensions

Unit:mm

No.	Style
1	
2	

Note

- This unit cannot be used in water.
- Please place purchase orders per minimum order unit N (integer).

ALPS

Detector

Push

Slide

Rotary

Encoders

Power

Dual-in-line
Package Type

TACT Switch™





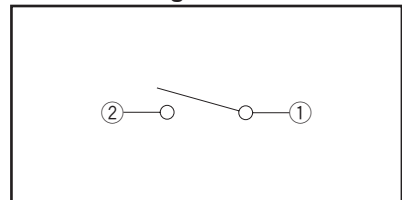







Custom-
Products

Circuit Diagram



Automotive
Use

List of Varieties (Water-proof Type / Telephone-hook Type)

Series	Water-proof Type					Telephone-hook Type	
	SPVQ4	SPVQ6	SPVQ7	SPVQA	SSCN	SPPY5	
Detector Photo							
Operation type							
Operating temperature range	-40°C to +85°C					-10°C to +60°C	
Automotive use	●	●	●	●	●	—	
Rating (max.) (Resistive load)	0.1A 12V DC					50mA 48V DC max.	
Rating (min.) (Resistive load)	50μA 3V DC	50μA 5V DC			100μA 3V DC		
Electrical performance	Initial contact resistance	500mΩ max.				100mΩ max.	
	Insulation resistance	100MΩ min. 500V DC					
	Voltage proof	500V AC for 1 minute					
Mechanical performance	Terminal strength	3N for 1 minute				5N for 1 minute	
	Actuator strength	20N			10N	5N	
Durability	Operating life without Load	300,000cycles 1Ω max.			100,000cycles 1Ω max.	300,000cycles 1Ω max.	
	Operating life with Load	(0.1A 12V DC) 300,000cycles 1Ω max.			(0.1A 12V DC) 100,000cycles 1Ω max.	(50mA 48V DC) 100,000cycles (100μA 3V DC) 300,000cycles	
Environmental performance	Cold	-40±2°C for 500h				-20±2°C for 96h	
	Dry heat	85±2°C for 500h				85±2°C for 96h	
	Damp heat	60±2°C, 90 to 95%RH for 500h				40±2°C, 90 to 95%RH for 96h	
Dimensions (mm)	W	14.7	13.3	14.7	15.2	13	14.4
	D	5.4	5.3	5.4	6.4	5	28.6
	H	7.6	7	6.7	7.95	25	7.15
Soldering	Manual soldering	300±10°C, 3 ⁺¹ s			—	300±10°C, 3 ⁺¹ s	350±5°C, 3s max.
	Dip soldering	260±5°C, 5±1s			—		
	Reflow soldering	—					Please see P.102
Number of poles	1					2	
Operation force	1±0.3N	3N max.	1±0.5N		2N max.	0.8N max.	
Page	92	93	95	97	99	100	

- Detector Switches Soldering Conditions102
- Detector Switches Cautions103