

DSM Series Ultra Thin Surface Mount Single Digit 7-Segment LED Display

DSM7UA70101 - 0.70" (17.78mm) Digit Height
Emitting Color: Red (AlGaInP/GaAs)

Applications

- People Movers
- Home Appliances
- Medical Devices
- Industrial Devices
- Automation and Controls
- Light Control
- IoT
- Transportation
- Food Service Appliances

Key Features

- 1-digit seven segment led numeric display
- Outer dimensions: 24.0 x 14.8 x 2.3mm
- Reduce overall thickness of PCB, with major cost savings
- Available in 4 different digit heights and widths
- Excellent character appearance, with high light output
- Super bright red chip
- Made from AlGaInP on transparent GaAs substrate
- Made of white segments and gray surface
- Also available in pure green
- Available in cut tape or automation-friendly tape and reel
- Exclusive patented technology
- Low current operation and lower power consumption
- Polarity: common anode
- Available for reverse mounting configuration
- Side by side mounting allows space saving
- Easy mounting on PC boards or sockets
- Moisture Sensitive Level (MSL): 2a
- Life expectancy: 100,000 hours
- Technically and mechanically rugged
- Quality tested with the highest industry standard

Ordering Data

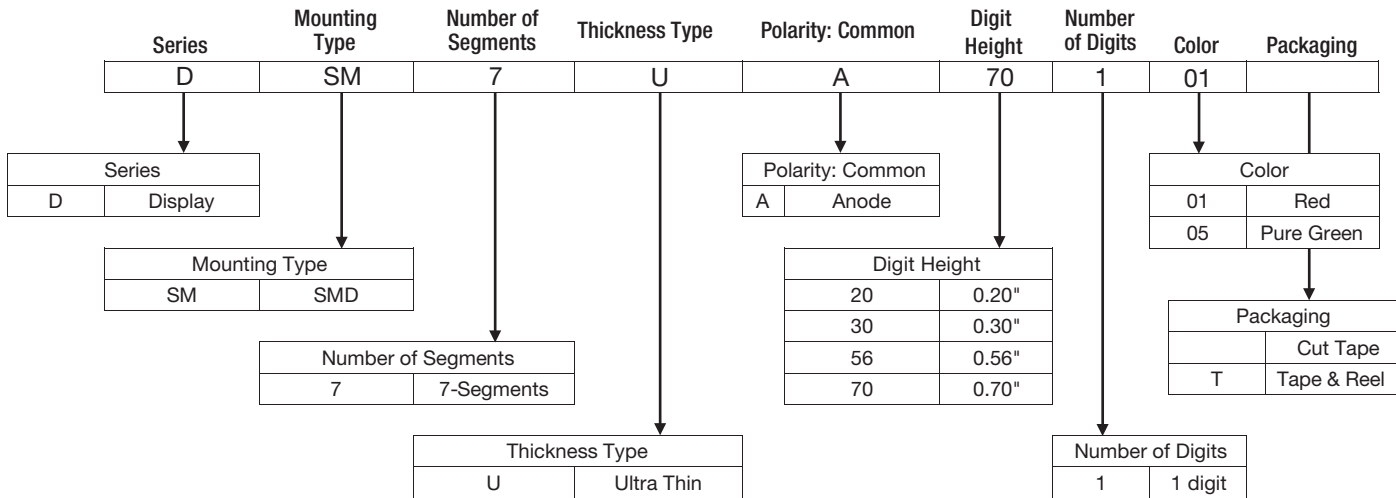

Dimensions and Internal Circuit Diagram

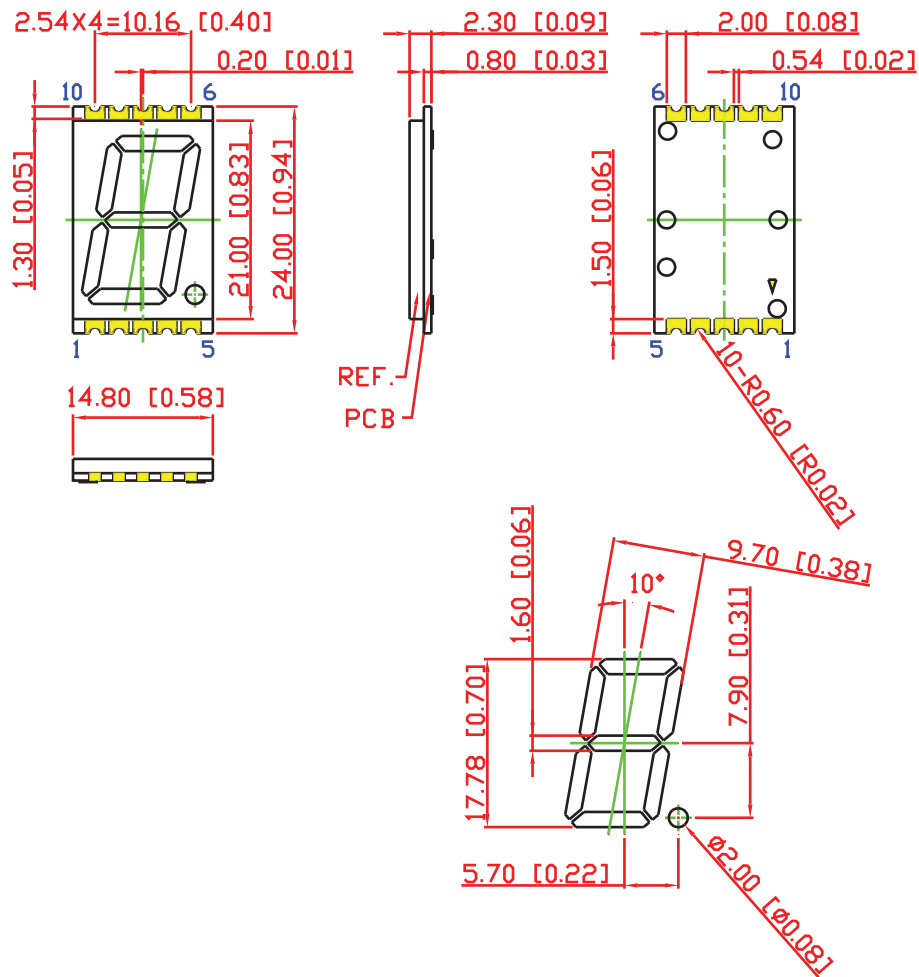

Dimensions in millimeters [inches]
Tolerance is $\pm 0.25\text{mm}$ [0.01"] unless otherwise noted

Dimensions and Internal Circuit Diagram

Recommended Reverse Mount Solder Pattern

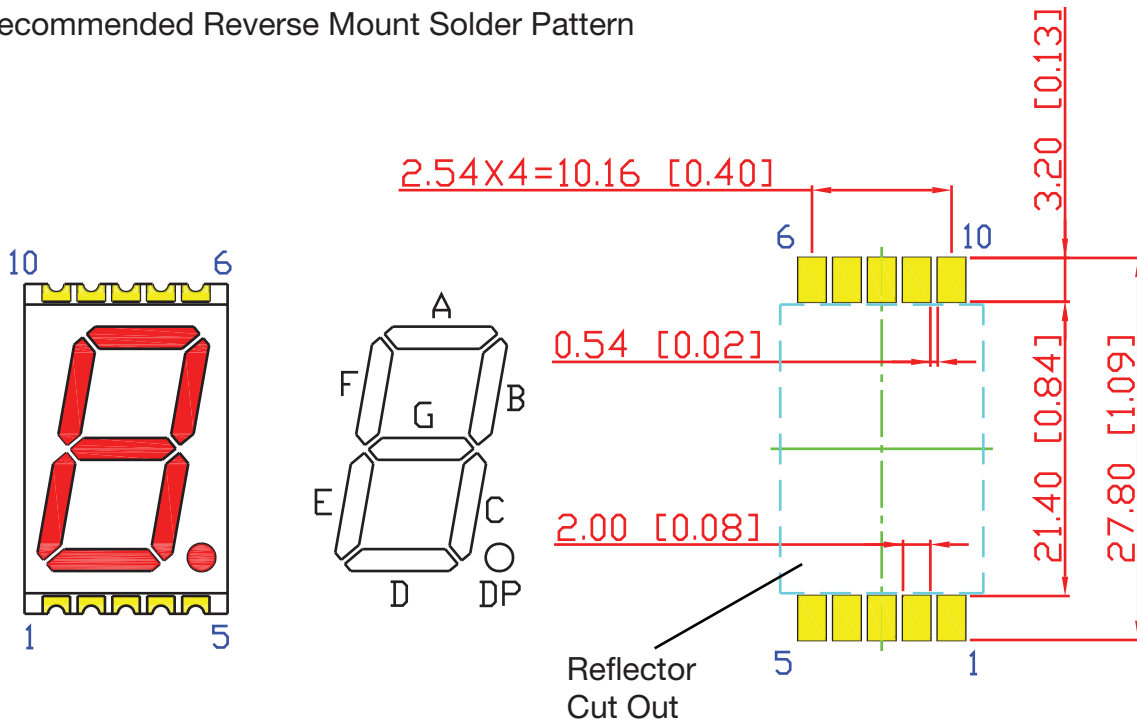

Dimensions in millimeters [inches]

Tolerance is $\pm 0.25\text{mm}$ [.01"] unless otherwise noted

Pin Connections (Common Anode)

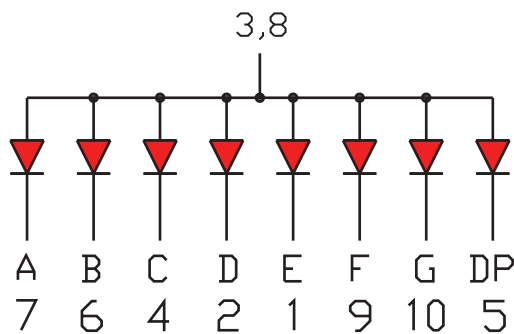

PIN No	Connection
1	CATHODE E
2	CATHODE D
3	COMMON ANODE
4	CATHODE C
5	CATHODE DP
6	CATHODE B
7	CATHODE A
8	COMMON ANODE
9	CATHODE F
10	CATHODE G

Product Specifications

Absolute Maximum Rating at Ta=25°C / 77°F (Ta= Ambient Temperature)

Parameter	Symbol	Maximum Rating	Unit
Power dissipation	P _{AD}	70	mW
Derating liner from 25°C/77°F	-	0.28/9.46	mA °C / °F
Continuous forward current	I _{AF}	25	mA
Peak current (duty cycle 1/10, 1kHz)	I _{PF}	90	mA
Reverse voltage	V _R	5	V
Operating temperature	T _{OPR}	-40 TO +105 -40 TO +221	°C °F
Storage temperature	T _{STG}	-40 TO +105 -40 TO +221	°C °F

Electrical - Optical Characteristics at Ta=25°C / 77°F (Ta= Ambient Temperature)

Charateristic	Symbol	Condition	Min.	Typ.	Max.	Unit
Forward Voltage, (Per Dice)	V _F	I _F =20mA	-	2.0	2.6	V
Reverse Current, (Per Dice)	I _R	V _R =5V	-	-	10	μA
Peak Wavelength	λ _P	I _F =20mA	-	632	-	nm
Dominant Wavelength	λ _D	I _F =20mA	619	-	629	nm
Luminous Intensity	I _V	I _F =20mA	25	-	80	mcd
Spectral radiation bandwidth	Δλ	I _F =20mA	-	20	-	nm

Product Specifications

Typical Electro-optical Characteristic Curves (25°C / 77°F Free Air Temperature Unless Otherwise Specified)

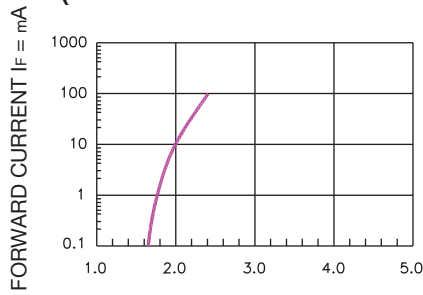

FORWARD CURRENT I_F (mA)
FORWARD CURRENT VS. FORWARD VOLTAGE

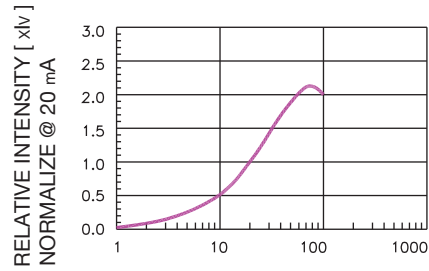

RELATIVE INTENSITY [xlv]
NORMALIZE @ 20 mA
FORWARD CURRENT I_F (mA)
RELATIVE INTENSITY VS. FORWARD CURRENT

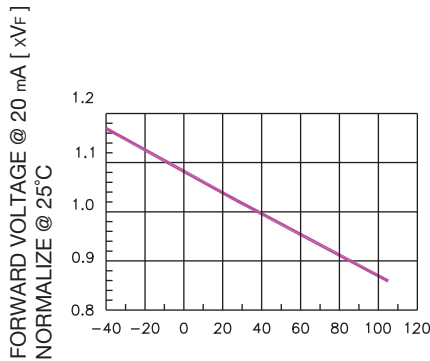

FORWARD VOLTAGE @ 20 mA [xVf]
NORMALIZE @ 25°C
AMBIENT TEMPERATURE T_a (°C)
FORWARD VOLTAGE VS. TEMPERATURE

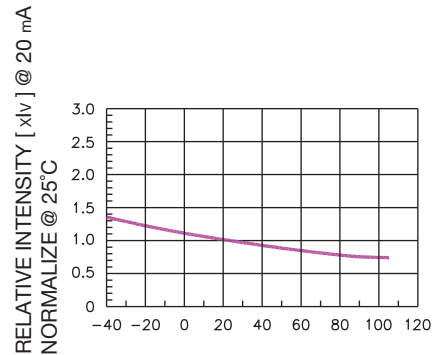

RELATIVE INTENSITY [xlv] @ 20 mA
NORMALIZE @ 25°C
AMBIENT TEMPERATURE T_a (°C)
RELATIVE INTENSITY VS. TEMPERATURE

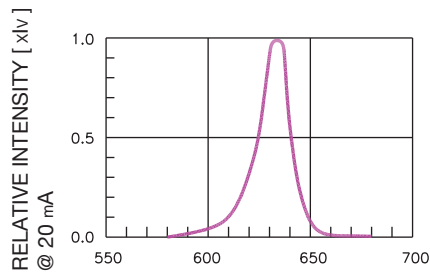

RELATIVE INTENSITY [xlv]
@ 20 mA
WAVELENGTH (nm)
RELATIVE INTENSITY VS. WAVELENGTH

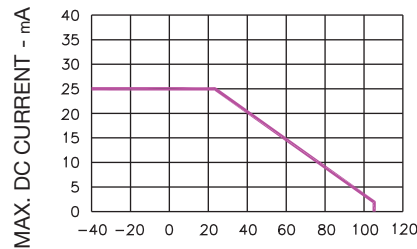

MAX. DC CURRENT - mA
AMBIENT TEMPERATURE T_a (°C)
MAX. ALLOWABLE DC CURRENT VS. AMBIENT TEMPERATURE

Circuit Design Notes

- Always use current limit resistors when necessary
- LEDs could be electrically connected in parallel, with each LED having its own current limiting resistor

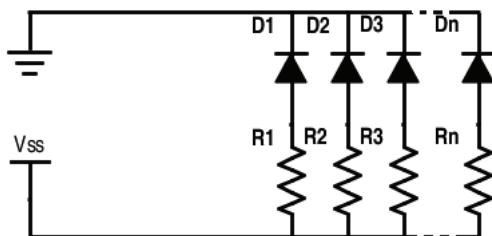

Correct

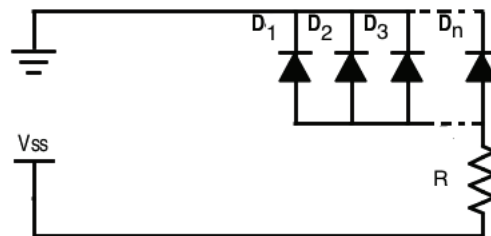

Incorrect

Recommended Reflow Soldering Profile

- SMT Reflow Soldering Instructions

SMT Soldering Profile
Pb free reflow soldering Profile

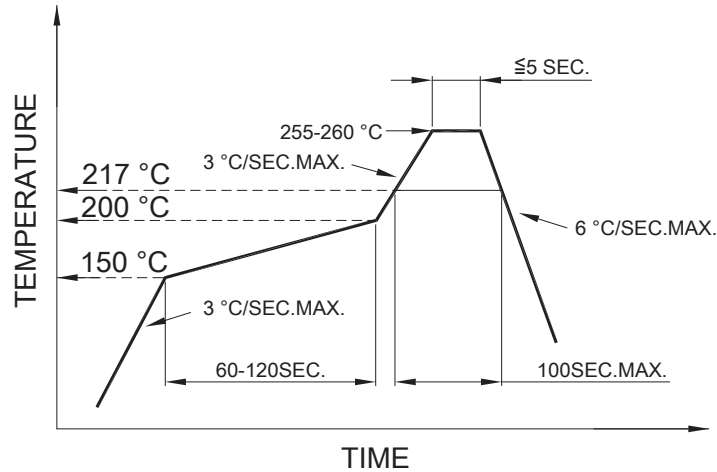

- We recommend the reflow temperature 245°C / 473°F (+/- 5°C / 41°F). The maximum soldering temperature should be limited to 260°C / 500°F.
- Number of reflow process shall be 2 time or less.

- Soldering Iron**

Basic spec is ≤ 4 sec when 260°C / 500°F. If temperature is higher, time should be shorter (+10°C / 50°F \rightarrow 1 sec). Power dissipation of Iron should be smaller than 15W, and temperature should be controllable. Surface temperature of the device should be under 230°C / 446°F.

- Rework**

- Customer must finish rework within 3 sec. under 350°C / 662°F.
- The head of soldering iron cannot touch copper foil.

Storage Condition

In factory original sealed bag package

TEMPERATURE CONDITION	HUMIDITY CONDITION
5°C ~ 30°C	Below 60%RH

After opened and not in factory original sealed bag package

TEMPERATURE CONDITION	HUMIDITY CONDITION	STORAGE TIME
5°C ~ 30°C	Below 60%RH	Within 4 weeks (MSL as level 2a)

Tape & Reel Dimensions

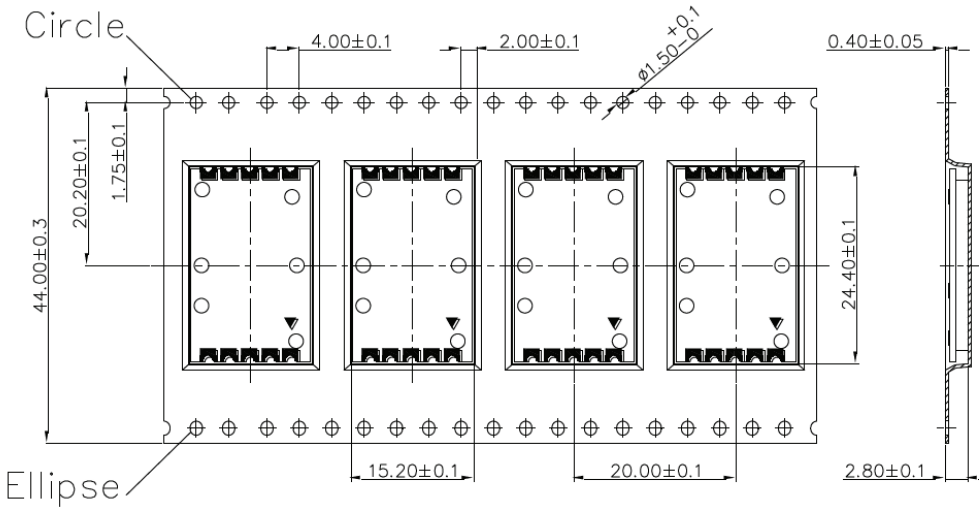
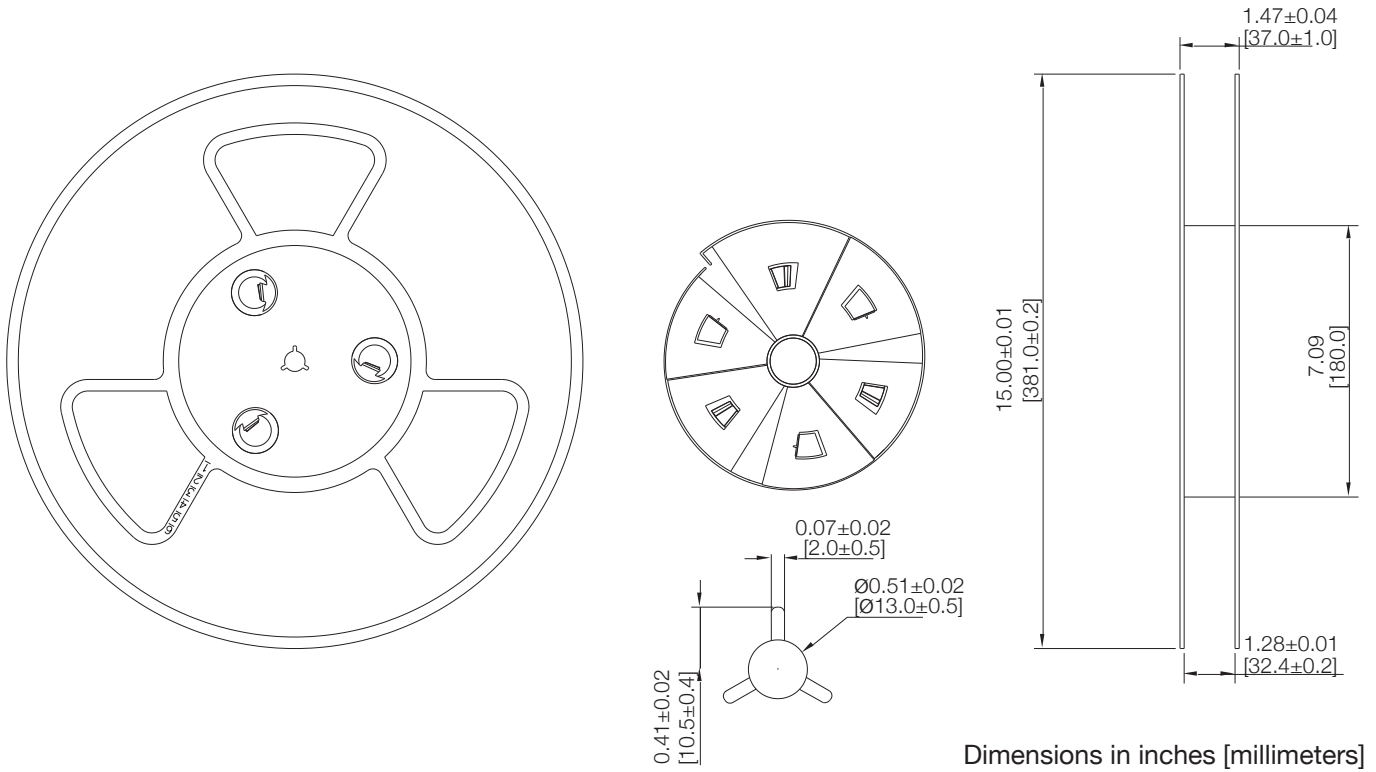

1000PCS / 1 REEL

Dimensions in millimeters

Compliance and Approvals

